



Republic of Kenya
Ministry of Health

Clinical Manual on
**Early Infant Male
Circumcision (EIMC)**
under local anesthesia

September 2014



Ministry of Health

Clinical Manual on Early Infant Male Circumcision (EIMC) Under Local Anesthesia

Acknowledgements

The development of this clinical manual on Early Infant Male Circumcision (EIMC) under local anesthesia was made possible by various stakeholders under the leadership of the Ministry of Health, National AIDS/STI Control Program (NASCOP) and the Neonatal Child and Adolescent Health Unit.

The manual was adopted from the “WHO and JHPIEGO manual for early infant male circumcision under local anesthesia”

NASCOP wishes to acknowledge with appreciation the financial and technical support of World Health Organization (WHO) and Centers for Disease Control and Prevention (CDC) Kenya.

Special appreciation goes to the members of the National VMMC taskforce and other stakeholders for their critical contributions to the process from adopting, drafting, reviewing and finalizing the guidelines. The scientific and technical role of the consultant Dr. John Wasonga in writing and compiling the guidelines is gratefully acknowledged.

The following individuals and partner organizations were involved in preparation of the guidelines:

Dr. George Githuka (NASCOP)

Dr. Odoyo June (CDC Kenya)

Prof. Robert Bailey (NRHS)

Fred Adera (NRHS)

Dr. James Odek (USAID)

Dr. Donath Emusu (CDC Kenya)

Dr. Kipruto Chesang (CDC Kenya)

Dr. Christine Kisia (WHO)

Dr. Brian Pazvakavambwa (WHO)

Mathews Onyango (FHI 360/MCC)

Dr. Duncan Odera (IRDO)

George Otieno (NRHS)

Francis Ndwiga (NASCOP)

Dr. Athanasius Ochieng (NASCOP)

Dr. Norah Talam (WRP)

We are also indebted to a team of County Directors of Health and County AIDS and STI Control Coordinators who made a thorough review of the Draft guideline and gave priceless insights. They include:

Dr. Ojwang Lusi (Kisumu)

Dr. Joseph Lenai (Nakuru)

Dr. Lotodo Lokwialuk (West Pokot)

Dr. Melsa Lutomia (Busia)

Samuel Pulkol (Turkana)

Dr. Willis Omwoyo (Homa Bay)

Erick Omondi (Siaya).

There are many others who have contributed to this document in one way or another, but who may not have been mentioned here. Thank you for your tireless efforts in this invaluable process.

Dr. Sirengo Martin

Head, National AIDS/STI Control Program

Foreword

The Ministry of Health remains committed to implementation of Voluntary male medical circumcision (VMMC) programs that are both effective and sustainable. The first phase of the National VMMC program targeting non-circumcising communities with high HIV incidence has successfully implemented and continues implementation. However, there has been noted demand in Early Infant Male Circumcision (EIMC) especially among the non-circumcising communities that have now embraced VMMC. This has necessitated the development of these guidelines to ensure that the procedure is conducted in safe and acceptable way, by qualified service providers and with the right equipment.

As we implement the second National VMMC strategy 2014/15 to 2018/19, there will be no targets set for the number of EIMCs performed. Focus will be on conducting safety and acceptability studies and well as demand creation for the service. Where found feasible the service providers will be trained on EIMC and their facilities equipped to perform the procedure in response to the demand.

From the onset, EIMC will be introduced as an integrated service within the maternal, neonatal and child health clinics. It is important therefore that the support given to facilities to perform the procedure is within the MNCH clinics.

Finally, I would like to reiterate that infant male circumcision is not an emergency procedure. The parents/guardians must give informed consent, the service providers must screen the infant to ensure that they are healthy; they must ensure that the infant is not suffering from any ill health including congenital anomalies before performing the male circumcision. Follow up must also be conducted and the outcomes of the procedure documented.

Appropriate implementation instruments will be put in place to operationalize these guidelines.

Dr. Nicholas Muraguri
Director of Medical Services

Table of Contents

Acknowledgements.....	2
Foreword.....	3
Chapter 1 Early Infant Male Circumcision Introduction	7
Summary	7
Timing of male circumcision – infancy versus adolescence/adulthood.....	8
Timing of male circumcision during infancy	9
Benefits and risks of male circumcision.....	9
Male circumcision and the effect on sexual satisfaction	11
Chapter 2 Elements of Quality System Management	12
Group education of parents / guardians on early infant male circumcision	12
Why group education?	12
Opportunities for group education on early infant male circumcision	12
Key Messages for group education for parents or guardians	13
What is Early Infant male circumcision?	13
What are the benefits of infant male circumcision?.....	13
What are the risks of infant male circumcision?	13
How is the procedure performed?	14
Post-operative care following EIMC.....	14
Postoperative care instructions.....	14
Rights of the Child.....	14
Characteristics or skills needed to conduct a good group education session.....	14
Tips for conducting an effective group education session	15
Parent/guardian individual counseling for early infant male circumcision.	15
Introduction and definition.....	15
Basic facts about counselling.....	15
The HIV Exposed Infant.....	16
Informed consent.....	16
Documenting Informed Consent for Surgery.....	16
Why Informed consent?.....	16
What are the legal requirements of informed consent?.....	16
Chapter 3 Screening for early infant male circumcision	17
Chapter 4 Preparation for EIMC	21
General preparation.....	21
Checklist for EIMC using Mogen clamp.....	21
Benefits of male circumcision.....	22
Risks of male circumcision	23
Chapter 5 Overview of facility and equipment requirements for EIMC. 24	24
Facility requirements.....	24
Equipment requirements and necessary supplies.....	24
Anaesthesia administration.....	25
Post-circumcision bleeding.....	25
Postoperative processing.....	25

Chapter 6	Anaesthesia for EIMC.....	27
	Safe injection of local anaesthetic.....	27
	Dorsal penile nerve block.....	28
	EMLA cream.....	29
	Other options for comfort.....	30
	Avoid Sedation.....	30
Chapter 7	Choice of Mogen clamp for EIMC in Kenya.....	31
	Reasons for choosing Mogen clamp for Kenya’s EIMC program.....	31
Chapter 8	EIMC using Mogen Clamp.....	34
	Mogen (Bronstein style) clamp: technique.....	34
	Mogen (Bronstein-style) clamp: device-specific complications.....	43
Chapter 9	Postoperative care.....	45
	Postoperative dressing.....	45
	Postoperative care instructions.....	46
Chapter 10	Possible Postoperative complications.....	48
	Immediate postoperative complications	48
	Post-circumcision bleeding.....	48
	Too little skin is removed.....	48
	Too much skin is removed (degloving).....	49
	Injury to penis or surrounding structure.....	50
	A thin mucosal layer is not excised.....	50
	Other postoperative complications.....	51
Chapter 11	Standard precautions and instrument processing.....	54
	Overview.....	54
	Standard precautions.....	55
	Surgical hand scrub.....	55
	Personal protective equipment.....	55
	Immunizations.....	56
	Safe handling of hypodermic needles and syringes.....	56
	Tips for the safe use of hypodermic needles and syringes:.....	56
Chapter 12	Monitoring and Evaluation.....	57
	Background.....	57
	Objectives.....	57
	Program monitoring.....	57
	Tools for M&E.....	58
	Indicators for monitoring EIMC.....	59
Chapter 13	Early Infant Male Circumcision service delivery and programme Management.....	60
	Service delivery planning and management.....	60
	Human capacity development.....	60
	Management of equipment, supplies and drugs.....	60
	Ensuring community involvement.....	60

Assessment and monitoring.....	60
Organization of services.....	61
Quality assurance.....	62
Referrals.....	63
Annex 1 Sample Checklist for early Male infant circumcision.....	64
Annex 2 Sample information sheet for early infant male circumcision....	65
Annex 3: Overview of counselling skills.....	66
Annex 4: Sample client record form for early infant male circumcision..	68
Annex 5: Reported inducers of methaemoglobinaemia.....	70
Annex 6: Sample checklist for early infant male circumcision procedure	71
Annex 7: Sample consent form for early infant male circumcision.....	73
Annex 8: Sample documentation form for early infant male circumcision procedure...	74
Annex 9: Overview of suturing and wound closure.....	75
Annex 10: Sample postoperative information sheet for early infant male circumcision.	76
Annex 11: Sample wound-dressing poster for early infant male circumcision.....	77
Annex 12: Sample postoperative bleeding protocol for early infant male circumcision....	78
Annex 13: Sample register for early infant male circumcision.....	79
Annex 14: Sample monthly facility summary form for early infant male circumcision...	80
Annex 15: Essential neonatal and infant care.....	81
Annex 16: Sample Infant Circumcision Lignocaine and Paracetamol dosing guide.....	83
Annex 17: Weight for Age Reference Guide.....	84
Annex 18: Standard Precautions for Injection Safety and Instrument Processing.....	85
References.....	90

Chapter 1

Early Infant Male Circumcision Introduction

Summary

Male circumcision is the surgical removal of all or part of the foreskin tissue (prepuce) that typically covers the tip or head of the penis. Derived from the Latin word *circumcido*, circumcision means, “cutting around”. During male circumcision, the foreskin is freed from the head of the penis (glans) and the foreskin is surgically excised.

Figure 1.1. An uncircumcised infant penis (left) and the same penis two weeks after male circumcision (right).

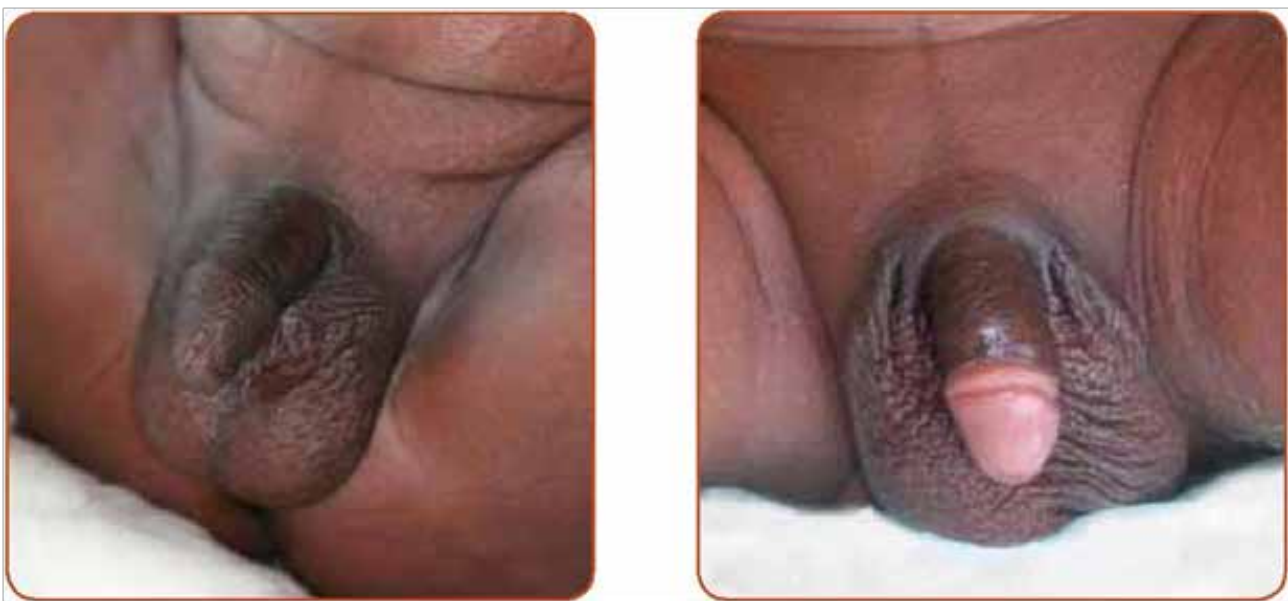

Male circumcision is widely practised for religious and traditional reasons, often within the first two weeks after birth or at the beginning of adolescence as a rite of passage into adulthood.^{5, 6, 7} As a medical procedure, it is performed to treat problems involving the foreskin and as a means to help prevent some diseases. Recently, three randomized controlled trials, including one from Kenya, have convincingly demonstrated that male circumcision reduces female to male transmission of HIV.^{8,9,10}

The decision to have a newborn male circumcised is very personal and should be made after careful consideration of the risks and benefits and cultural, religious, and personal preferences.

The following information is provided to help families, caregivers, and health-care workers make an informed decision about male circumcision.

Timing of male circumcision – infancy versus adolescence/adulthood

Male circumcision can be performed at any age. Several factors should be considered when determining its timing.

One important advantage of infant male circumcision is that the procedure is simpler than that performed on older boys and men because the penis is less developed and the foreskin is thinner and less vascular. Healing is quicker and complication rates are lower. The period of clinical wound healing after infant male circumcision is generally 5–7 days and most wounds heal completely within 14 days. Performing circumcision in infancy provides several other advantages:

- the wound typically does not need to be sutured;
- the procedure is not complicated by erections, which can be problematic in adolescent boys and men;
- infant male circumcision ensures that the wound will be healed before sexual activity begins; sexual activity can complicate circumcision in adolescents and adult males and can put older patients who engage in such activity before the wound has healed at higher risk for HIV transmission.

Another advantage of early infant male circumcision is the reduced risk of urinary tract infections in the first 6 months of life.¹¹ These infections typically present with signs and symptoms of systemic involvement and can be associated with significant complications, including sepsis and renal scarring. The benefit of male circumcision in preventing urinary tract infections in the first 6 months of life cannot be realized if the procedure is delayed until after infancy. This is especially pertinent if there is an underlying uropathy, such as vesicoureteral reflux or urinary tract obstruction.

Health workers and parents/guardians need to remember that infant male circumcision is generally simpler, the healing time tends to be shorter and the complication rates associated with the procedure are lower than when it is performed in later life.

A concern about early infant male circumcision is that the child cannot give informed consent for the procedure. Moreover, some of the health benefits, including reducing the risk of HIV infection, will not be realized until many years later when the person becomes sexually active. If circumcision is postponed until an older age the client can evaluate the risks and benefits and consent to the procedure himself.

Programmes that promote male circumcision in early infancy are likely to have lower adverse event rates and lower costs than programmes targeting adolescent boys and men. However, these considerations must be balanced by concerns about consent.

Timing of male circumcision during infancy

A WHO expert review meeting on neonatal male circumcision held October 2009 in Geneva Switzerland concluded that the procedure is easier to perform and associated with fewer complications when performed within the first two months of life.

It is recommended that infant male circumcision not be performed until at least 12 to 24 hours after birth to ensure the infant is stable. This time allows providers to perform neonatal care and treatment, to completely assess the neonate and to identify abnormalities or contraindications.¹³ Other considerations prior to circumcision are allowing initiation of breastfeeding (according to mother's choice) and allowing the infant to void.

Data also suggest that male infants of low birth weight (less than 2500 g or 5 lb 9 oz) should undergo delayed outpatient circumcision¹⁴ and that circumcision should be delayed in infants whose penile shaft length is less than 1 cm.¹⁵ Early infant male circumcision is also not recommended in preterm infants (less than 37 completed weeks gestational age) or any infant with a medical contraindication (see Chapter 4).

Early infant male circumcision should only be performed on full/term infants weighing 2500g or more and without a medical contraindication. The exact timing of male circumcision within the first 60 days of life should be based on the assessment and care of each individual infant. The infant must have normal weight for age at the time of circumcision.

Benefits and risks of male circumcision

Benefits

If infant male circumcision is being performed for reasons other than the treatment of a specific medical problem, the health benefits are primarily preventive and may only be realized long after the procedure has been carried out. Circumcision may reduce the risk of acquiring some infections and related complications but does not guarantee complete protection. Some of these conditions are not as common as others, and the degree of risk may depend on the behaviours of the individual and the community to which he belongs. The benefits of male circumcision include the following;

Decreased risk of urinary tract infections – male circumcision decreases the risk of such infections in infants¹⁹ and adult men.²⁰ Uncircumcised male infants are estimated to have a 1% chance of acquiring a urinary tract infection. This type of infection is 10 times less common in circumcised male infants, who have an estimated 0.1% chance of developing such an infection.²¹

- Prevention of phimosis – this condition results from scar tissue that makes a tight opening in the foreskin and prevents exposure of the head of the penis and the normal retraction of the foreskin.²²
- Prevention of paraphimosis – this is a rare condition that occurs when the foreskin is pulled back or down and trapped in the retracted position below the glans. The tissue can become swollen and obstruct the blood flow to the tip of the penis, requiring urgent surgery to correct the problem. Male circumcision can prevent this complication.^{23, 24}
- Prevention of balanitis and posthitis – under certain circumstances, dirt, sand and other irritants can collect under the foreskin and cause inflammation of the glans (balanitis) and foreskin (posthitis).
- Male circumcision helps to prevent these conditions by making it easier to keep the head of the penis clear of possible irritants.^{25, 26}
- Decreased risk of other sexually transmitted infections – male circumcision has been shown to help protect against genital ulcer disease and human papillomavirus (HPV).^{27, 28}
- Decreased risk of HIV infection – male circumcision has been proven to help prevent female to male transmission of HIV, reducing the risk of transmission by 60–70%.^{16, 17, 18}
- Decreased risk of cancer of the penis, which, in some populations, occurs in 1 per 100 000 people and is much more common in men who are uncircumcised. Male circumcision markedly reduces the risk of developing this type of cancer.^{29,30}
- Decreased risk of cancer of the cervix in female sexual partners – cervical cancer occurs less commonly in women who have male sexual partners who are circumcised. Sex with uncircumcised men increases a woman's risk of cervical cancer.³¹
- Decreased vaginal infections caused by *Trichomonas vaginalis* and decreased bacterial vaginosis in female sexual partners.³²

Male circumcision provides several medical benefits. In 2007, UNAIDS and WHO concluded that the efficacy of male circumcision in reducing female to male transmission of HIV had been proved beyond reasonable doubt.³³

Risks

As with any surgical procedure there are risks associated with male circumcision. While the benefits of circumcision may be wide-ranging and long-term, most problems which arise from this surgery generally occur during or soon after the procedure. Risks associated with male circumcision include:

- pain, which can be minimized through the use of anaesthesia;
- bleeding, including the risk associated with a blood transfusion in the extremely rare case of life-threatening bleeding, most often associated with an underlying bleeding disorder;
- infection, including the risk of systemic spread and the need for intravenous antibiotics;
- injury to the penis and surrounding structures, including the urethra, glans and scrotum;
- poor cosmetic outcomes, i.e. general dissatisfaction with the appearance of the wound, adhesions, buried/concealed penis, removing an excess or an insufficient amount of foreskin, preputial-glandular fusion, and skin bridges;
- meatitis – inflammation of the opening of the urethra;
- meatal stenosis – scar formation over the outlet of the urethra;
- reactions to the anaesthetic agent.

When male circumcision is performed by well-trained, adequately equipped and experienced health-care personnel, these complications are minor and rare, occurring in 1 of every 250 to 500 cases.^{34, 35} Most of the complications can be easily and rapidly addressed and do not result in significant morbidity or mortality.

Where there is a lack of formal training programmes, uniform policy and adequate equipment and resources, complication rates as high as 20% have been reported.^{36,37} These data highlight the importance of education, training and establishing a uniform standard of care. Evidence suggests that this approach can be very effective in optimizing male circumcision outcomes.^{38, 39}

Complications during male circumcision are rare when performed by well-trained, adequately equipped and experienced providers. Unbiased information must be provided to families and legal guardians on the benefits and risks of this procedure so that they can make informed decisions for their infants.

Male circumcision and the effect on sexual satisfaction

Some adults and parents are concerned that male circumcision will diminish male and possibly female sexual enjoyment and satisfaction later in life. Recent studies show no evidence of this. A randomized controlled trial evaluated the question in 4456 sexually experienced adult males and found that male circumcision did not adversely affect sexual satisfaction or clinically significant function in men.⁴⁰ These findings were confirmed in another large randomized controlled trial that found adult male circumcision was not associated with sexual dysfunction and that circumcised men reported increased penile sensitivity and enhanced ease of reaching orgasm.⁴¹ Another study showed that male circumcision had no deleterious effect on female sexual satisfaction.

The existing evidence indicates that male circumcision is unlikely to adversely affect male sexual function or female sexual satisfaction.⁴²

The existing evidence indicates that male circumcision is unlikely to adversely affect male sexual function or female sexual satisfaction.

Chapter 2

Group education and individual counselling

Group education of parents / guardians on early infant male circumcision

Introduction

Group education is used to support individual counselling services. It allows clients to be given basic information about male circumcision before an individual counselling session. Counsellors can then work with the parents to their clients on specific issues related to male circumcision or sexual and reproductive health in general.

The information given to clients during an education session may differ slightly from site to site. Counsellors should be familiar with the standard education on male circumcision offered where they work, so that messages and information given are consistent.

Why group education?

Health education increases awareness and favourably influences attitudes and knowledge related to the improvement of health on a personal basis. Group education is used to support individual counselling services. It allows clients to be given basic information about male circumcision before an individual counselling session. It also allows the first counselling session to be shorter, which is an advantage in busy clinics. Counsellors can then work with parents or guardians on specific concerns related to infant male circumcision. Consideration should be given to the local cultural context when providing group education.

Opportunities for group education on early infant male circumcision

There are many possible opportunities to provide education about male circumcision. Health workers need to take advantage of every available opportunity to provide health education to their clients and ensure that the information given is clear, consistent and complete. The following settings and services present opportunities for group education and integration of EIMC;

Antenatal care clinics

The circumcision of male infants should form an integral part of the basic information that is given to pregnant women, so that they can start thinking about it, discuss it with their spouse or partner or the father of the child and have any questions clarified.

Postpartum services

The presence of the neonate provides the most timely opportunity to discuss male circumcision. The package of care at this time should include EIMC. Information should be given to mothers/parents before discharge and also at the follow-up postpartum visits.

Well-child and immunization services

Parents or guardians should be receiving information about male circumcision during the well-child clinics and immunization visits to help them make a decision if they have not already done so.

Home-based Services

Information on early infant male circumcision can be offered to a family that is at an appropriate life stage during domiciliary visits or at any other time when a health-care provider or community health worker visits the home of the client.

Adult outpatient clinics

Information on early infant male circumcision can be provided as part of other routine group education sessions while parents are waiting to see the provider for other reasons.

Adult male medical circumcision services

As men of reproductive age present for male circumcision for themselves the possibility of infant male circumcision for their potential future neonates should be shared.

Key Messages for group education for parents or guardians

The information given to parents or guardians during an education session may differ slightly from site to site. Counsellors should be familiar with the standard education on early infant male circumcision offered at the place where they work, so that the messages and information given are consistent. In conducting group education on early infant male circumcision the following should be included;

What is Early Infant male circumcision?

Early Infant Male Circumcision is the surgical removal of the foreskin of the penis (also called the prepuce) within the first 60 days life. It is one of the oldest surgical procedures in history.

What are the benefits of infant male circumcision?

Infant male circumcision has been shown to have several health benefits including:

- decreasing the risk of urinary tract infections in young children;
- reducing the risk of some of the sexually transmitted diseases, e.g. herpes, in the future;
- giving some protection against cancer of the penis; in future;
- reducing the risk of acquisition of HIV in future;
- reducing the risk of cervical cancer in female sexual partners; in future;
- Preventing several medical problems of the penis and the foreskin, e.g. inflammation, scarring and swelling of the foreskin (balanitis, phimosis and paraphimosis).

Health workers and parents/guardians need to remember that infant male circumcision is generally simpler, the healing time tends to be shorter and the complication rates associated with the procedure are lower than when it is performed in later life.

What are the risks of infant male circumcision?

As with any surgical procedure or circumcision, complications may sometimes follow the operation, even though everything possible has been done to reduce the risk. Possible problems include pain, bleeding, swelling of the penis caused by bleeding under the skin (haematoma), injury to the surrounding structures and infection of the surgical wound.

How is the procedure performed?

The clinician should describe the Mogen clamp technique or any Ministry of Health approved technique used in the specific clinic. Infants can go home shortly after the procedure. Emphasize that local anaesthesia will be used to help minimize the pain of the procedure.

Post-operative care following EIMC

Petroleum jelly is applied to the wound immediately after the procedure before the dressing, when changing dressing and regularly until the wound is healed. It is applied liberally to cover the circumcision wound and the glans. It helps to achieve the following:

- protects the wound
- create a barrier between the healing surfaces of the foreskin and denuded areas of the glans
- keeps the wound from sticking to the nappy/diaper

A sterile dressing is applied over a surgical wound for the first 24 hours to prevent infection of the wound, protect the wound and to control bleeding and swelling.

Dressing should be replaced if baby passes urine and if it falls off before 24 hours.

Check dressing from time to time to ensure that it does not block the urine outlet and that there is no bleeding.

Postoperative care instructions

Written post-operative care instructions should be reviewed with the parent/guardian before discharge and given as a handout for family or carers.

The family should be instructed to return to the health clinic for any of the following reasons.

- The infant appears to be distressed or in pain.
- The infant cries a lot/ is irritable/ inconsolable.
- The infant is lethargic.
- The infant has hotness of the body/ fever.
- The infant does not wake for feeding in accordance with his usual pattern.
- There is any separation of the skin edges.
- There is any unusual swelling or bleeding.
- There is a discharge or foul smell associated with the wound
- The infant has any difficulties with urination.

The family has any other concerns.

Rights of the Child

Characteristics or skills needed to conduct a good group education session

Group education on early infant circumcision may be given by volunteers, staff (counsellors, nurses) or students who provide group education on a regular basis. It should be relatively consistent across sessions and standard content should provide parents or guardians with the same information about early infant male circumcision. When educators/counsellors are well skilled they can adapt the content to the group and avoid repeating information that parents or guardians already know, or can clarify misconceptions.

Tips for conducting an effective group education session

- It is best to use a guide / job aid to help provide group education. An infant male circumcision information sheet is provided in Annex 2.
- Encourage all parents or guardians to participate in the session. Make participants feel welcome and be open to discussion.
- Introduce the topic clearly and state the objectives.
- Consider local cultural needs. Use appropriate topics and choose words that the group can understand.
- Ask questions to find out what the group knows before providing all the information. It is pointless to give information the group already possesses.
- Use an interactive approach. Ask and answer questions and encourage group members to ask questions.

- Provide positive feedback to group members when they participate.
- Use education materials as appropriate.
- Maintain eye contact or appropriate cultural non-verbal communication with the group.
- Speak loudly enough to allow everyone to hear.
- Summarize key points.
- ensure that parents or guardians with very ill babies receive immediate care.

Parent/guardian individual counseling for early infant male circumcision

Introduction and definition

Health education and counseling are closely linked. Counselling is a two-way interactive process between client and provider. It is an interpersonal, dynamic communication process used to help people examine personal issues and make decisions and plans for taking action. Health-care providers have an important role to play in counselling women and men to adopt effective prevention strategies. In counselling for infant male circumcision the provider ensures that parents or guardians have all the information they need and that they can discuss their concerns in more depth than in group education sessions in order to make a decision about their infants undergoing the procedure.

Basic facts about counselling

Counselling uses individual communication to help people examine personal issues, make decisions and plans for taking action. In some types of counselling, the counsellor and client talk about whatever the client wishes. In counselling for early infant male circumcision the provider ensures that the client (his parents/guardians) has all the information he needs to make a decision about undergoing the procedure. Counselling involves a kind of contract between client and counsellor, the latter being bound by a code of ethics and practice. (See also Annex 3 of this Manual, as well as the National Guidelines on HIV Testing and Counselling in Kenya, published by NASCOP/MOH.)

Counselling is not:

- telling parents /guardians what to do;
- criticizing parents or guardians;
- forcing ideas or values on parents or guardians;
- taking responsibility for parents' or guardians' actions or decisions.

The HIV Exposed Infant

EIMC is offered to all clinically healthy infants regardless of their HIV exposure status, or that of their parents. Parents who choose EIMC for their HIV-exposed young infants should be made aware that the benefits in their case do not include protection from HIV.

Informed consent

Informed consent is the process by which the treating health care provider discloses appropriate information to a competent patient so that the patient may make a voluntary choice to accept or refuse treatment. An informed consent can be said to have been given based upon a clear appreciation and understanding of the facts, implications, and future consequences of an action. In order to give informed consent, the individual concerned must have adequate reasoning faculties and be in possession of all relevant facts at the time consent is given. Impairment to reasoning and judgment which may make it impossible for an individual to give informed consent include such factors as basic intellectual or emotional immaturity, high levels of stress such as PTSD or a severe intellectual disability, severe mental illness, intoxication, severe sleep deprivation,

Alzheimer's disease, or being in a coma.

Process of informed consent

- Give information
- Assess understanding
- Assess capacity of the guardian to make a decision

Documenting Informed Consent for Surgery

The circumcision team should ensure that the client has been informed about the risks and benefits of male circumcision and that the information has been given in an understandable way, using simple every day local language. The oral information should be backed by printed information sheets in the local language. After receiving the information, the client should be allowed to ask questions as well as time to reflect before being asked to sign the consent document

Why Informed consent?

It originates from the legal and ethical right the patient has to direct what happens to their body and from the ethical duty of the physician to involve the patient in their health care.

What are the legal requirements of informed consent?

The Kenya government has developed informed consent laws to govern certain types of communication between health providers and patients. These laws list the types of information that patients must be given so they can make an informed decision about having medical care, diagnostic tests, or treatment. These laws apply to doctors and sometimes to nurses.

Chapter 3

Screening for early infant male circumcision

The screening procedure for infants is aimed at ensuring that they are eligible for circumcision. If there is any doubt, circumcision should be deferred and any identified problem managed appropriately based on best clinical judgment or through referral to a specialist.

Circumcision providers should take a thorough health history and physical assessment of the young infant. In the case of very young babies, enquiries should be made about whether the pregnancy and delivery were normal. Early infant circumcision should be undertaken only if the infant is healthy, full-term and weighs 2500g or more. Only babies who are normal on physical examination with a normal weight for age index and an intact penis of completely normal appearance should be considered for male circumcision.^{45, 46}

Contraindications for early infant male circumcision include any known haematological disorders and jaundice. Thus any infant with yellow sclera or purpuric skin lesions should not be accepted for clinic-based circumcision. Any congenital abnormality of the genitalia is a contraindication.

If an abnormality exists the foreskin should be left intact because the tissue may be required to repair the defect.

Routine early infant male circumcision should only be undertaken if the infant is healthy, with a normal weight for age index, is normal on physical examination, and has an intact penis and scrotum of completely normal appearance. Haematological disorders like haemophilia need to be excluded

The following photographs are examples of congenital abnormalities that are contraindications to early infant male circumcision.

Figure 4.1. Bilateral hydroceles



Figure 4.2. Curvature with penile torsion



Figure 4.3. Penile torsion

Figure 4.4. Absence of ventral foreskin



Figure 4.5. Concealed penis (left) trapping urine beneath the foreskin (right)



Figure 4.6. Concealed penis on inspection (left) and during exam (right)



Figure 4.7. Megalourethra with deficiency of corpus spongiosum



Figure 4.8. Penoscrotal webbing on inspection (left) and during exam (right)



Figure 4.9. Epispadias and dorsal curvature on inspection (left) and during exam (right)



Figure 4.10. Hypospadias during exam (left) and prior to repair (right)



Health workers and parents/guardians need to remember that infant male circumcision is generally simpler, the healing time tends to be shorter and the complication rates associated with the procedure are lower than when it is performed in later life.

Chapter 4

Preparation for EIMC

General preparation

As a general rule, a well established management and referral system to specialist surgeons and paediatricians should be put in place before facilities begin to offer EIMC services.

For good outcomes and to avoid complications, providers should follow a standard procedure. 63A procedural checklist for early infant male circumcision using Mogen clamp is provided below and in more detail in Annex 1 of this manual.. This should be posted and reviewed before beginning the procedure.

Checklist for EIMC using Mogen clamp

Equipment

- Secure work surface (table or infant warmer) with sufficient height for provider.
- Assistant or mechanism to restrain/position infant.
- Check hand washing or cleaning facilities.
- Check light source or use a room with adequate natural light

Supplies

- Infant padding blankets and towels.
- Clean nappies/diapers and wipes.
- Sterile gloves.
- Sterile drape
- Povidone Iodine or other skin-sterilizing preparations.
- Sterile 2 x 2 or 4 x 4 gauze pads.
- White petroleum jelly or white petrolatum gauze.

Instruments

- Instrument trays, wrapped and sterile.
- One 7.5-cm to 12.5 cm blunt probe.
- Three small mosquito haemostats, all straight.
- Small straight scissors.
- Mogen Clamp
- Scalpel (no. 10 blade or similar).

Anaesthesia administration

- 1% lidocaine (WITHOUT EPINEPHRINE).
- 1-ml sterile syringes with small 27-gauge or similar needle.
- Alcohol wipes.

Supplies for managing Post-circumcision bleeding

- Topical epinephrine.
- Gel foam or equivalent.
- Adson forceps.
- 4-0 absorbable suture (chromic or catgut) on a round-bodied needle (G 24-25).
- Needle holder.

- Petroleum-coated gauze.
- Vitamin K.

Do the following before proceeding with Early Infant Male Circumcision.

Ensure availability of appropriate equipment and supplies

Confirm availability of equipment and supplies listed in table XX above.

Provide information to parents / legal guardians

Inform parents/guardians of the risks and benefits of male circumcision. Information sheet in annex 2 should be reviewed with the parent(s) or legal guardian(s).

Obtain informed consent

Informed consent must be obtained. Annex 7 gives an early infant male circumcision consent form that should be reviewed with parent(s)/guardians and signed.

Thoroughly wash/clean hands

Before proceeding with male circumcision the young infant must be examined closely. This should only be done after thorough washing with soap and water and drying of the hands.

Screen the young infant

Screen the young infant to determine his eligibility for circumcision. A thorough history should be obtained and the patient should be examined carefully. Only healthy, active babies with an intact foreskin of normal appearance should be considered for circumcision. Infants with a family history of bleeding disorder, illness or any urological abnormality should be excluded and referred for appropriate care.

Avoid feeding restrictions

Though it is a standard surgical precaution to restrict oral intake before surgery because of the risk of regurgitation and aspiration, this typically does not apply to minor outpatient surgeries performed under local anaesthesia and should not be considered a necessity for early infant male circumcision.

Verify identity of the baby before the procedure

Ensure that the correct baby is brought to the procedure room and that he remains a suitable candidate for male circumcision.

Annex 2: Information sheet for early infant male circumcision

Circumcision is the surgical removal of all or part of the foreskin covering the end of the penis. The decision to have a male infant circumcised is very personal and should only be made after careful consideration. The following information is provided to help you make an informed decision. We encourage you to discuss any questions or concerns with your health-care providers.

Benefits of male circumcision

1. Cleanliness – Under certain circumstances, dirt, sand, lint and other irritants can collect under the foreskin and cause inflammation and infection. Male circumcision helps to prevent this type of irritation and makes it easier to clean the head of the penis.
2. Prevention of paraphimosis, an extremely rare condition that occurs when the foreskin becomes retracted or pulled down below the tip of the penis and becomes stuck. The tissue can become swollen and can decrease the blood flow to the tip of the penis, requiring urgent surgery to correct the problem. Circumcision prevents this complication from occurring.

3. Decreased risk of urinary tract infections. Circumcision decreases the risk of urinary tract infections in males, both infants and adults. Uncircumcised infants have a 1% chance of acquiring a urinary tract infection. This type of infection is 10 times less common in circumcised infants, for whom there is only a 1 in 100 (1%) chance of developing a urinary tract infection.
4. Decreased risk of HIV infection. Circumcision has been proved to help prevent female to male transmission of HIV, reducing the risk of transmission by 60–70%.
5. Decreased risk of other sexually transmitted diseases. Circumcision has been proven to help protect against contracting genital herpes and some other sexually transmitted diseases.
6. Prevention of cancer of the penis. Cancer of the penis is extremely rare but occurs much more commonly in men who are uncircumcised than in those who are circumcised.
7. Prevention of cervical cancer in female sexual partners. Cervical cancer is less common in women who have sexual partners who are circumcised. Sex with either uncircumcised men or men circumcised after infancy increases a women's risk of cervical cancer.
8. Avoiding the need for circumcision later in life. Some uncircumcised males will require circumcision later in life for medical reasons.

Risks of male circumcision

1. Lack of informed consent. An infant cannot consent to the procedure. The decision must be made by the family. The procedure is considered permanent and there is a risk that when the child is older he will be unhappy that he was circumcised as an infant.
2. Pain. This can be reduced and even eliminated with the use of safe and effective medications. Please discuss the use of pain medication with your health-care team.
3. Surgical risk. Complications during male circumcision are rare, being estimated to occur in 1 of every 500 procedures. These complications, which can be severe, include poor cosmetic outcome (appearance), bleeding, infection, injury to the penis and the removal of too much or too little skin.
4. Expense. There may be a cost associated with the procedure.
5. Change in sexual satisfaction. Some people believe that circumcision leads to decreased sexual pleasure later in life. Data recently collected from a large group of adult males who underwent circumcision later in life suggest that there is no difference in sexual satisfaction between circumcised and uncircumcised men and their partners.
However, some patients may be unhappy that they were circumcised.

Chapter 5

Overview of facility and equipment requirements for EIMC

Facility requirements

The following criteria should be considered when evaluating a facility for early infant male circumcision:

- preferably close to maternal, neonatal and child health (MNCH) services;
- facility meets standards for universal precautions;
- facilities to wash/clean hands;
- a clean room with good lighting (a theatre setting is not required);
- ability to provide postoperative care;
- resources for contaminated waste disposal;
- health-care workers trained to perform early infant male circumcision;
- health-care workers trained in caring for postoperative circumcision wounds and recognizing and treating complications of early infant male circumcision;
- access to care for routine follow-up and post-procedure emergencies.

Equipment requirements and necessary supplies

The following items must be immediately available and routinely checked before beginning any case in order to optimize safety during standard early infant male circumcision. (An equipment checklist is provided in Annex 1.)

Equipment

- Secure work surface (table or infant warmer) – height should be such that the surgeon does not have to stoop or bend
- Baby restraint board
- A means of hand-washing or disinfection
- Source of light

Supplies

- Source of warmth
- Clean nappies/diapers and wipes
- Sterile gloves
- Sterile drape
- Povidone iodine or other skin-sterilizing preparation
- Sterile 2 x 2 or 4 x 4 gauze pads – 10 pieces
- Petroleum jelly or white petrolatum gauze
- Basic Equipment and supplies for Newborn resuscitation
- Suction device (Plastic bulb syringe)
- Ambu-bag and mask (500ml)
- Heat source (lamp) to provide warmth, if possible.
- Source of oxygen
- Oxygen mask
- Wall Clock
- Pediatric Stethoscope
- Epinephrine 1:1000
- Sodium bicarbonate
- Vitamin K injection

Instruments

- Instrument tray wrapped with sterile drape
- One 7.5-cm to 12.5-cm (3-inch to 5-inch) blunt probe
- Three small straight mosquito artery forceps
- Small straight scissors
- Mogen clamp
- Sterile surgical blade-no. 10
- Surgical blade handle- no. 3
- Kidney dish – medium
- Galipot – small

Anaesthesia administration

- 1% lidocaine (WITHOUT EPINEPHRINE) or diluted 2% Lidocaine (See Dilution Chart in Annex...)
- 1-ml sterile syringe with small 27-gauge needle
- Alcohol wipes

Post-circumcision bleeding

- Topical epinephrine
- Gelfoam or equivalent
- Adson forceps
- 4-0 absorbable suture (chromic or catgut) on a needle (4-0 chromic on PC-1 needle or equivalent)
- Needle-holder
- Petrolatum-coated gauze

Postoperative processing

- Check sterilizing and reprocessing equipment
- Check that means are available to handle and dispose of contaminated sharps
- Check that means are available to handle and dispose of contaminated supplies
- See annex for instrument processing list of equipment

Surgical instruments wear out with use and repeated disinfection and sterilization. Each clinic should therefore carry out a periodic review of surgical instruments (see Annex 1 for sample equipment checklist). Failure to maintain instruments in good working condition can result in operative difficulties and complications. Haemostats, scissors, needle-holders and clamps should be checked routinely to ensure that they are in working order.

Researchers have shown that the foreskin is enriched with HIV-1 target cells, providing evidence of a biological explanation for the protective effect of male circumcision against HIV transmission.^{43,44} This susceptibility of the foreskin means that extra vigilance is required when delivering male circumcision care, particularly in settings with a high prevalence of HIV infection. Instruments, needles, clamps and supplies must be sterile and meticulous sterile technique must be maintained to ensure that each patient and provider is protected from HIV exposure.

Before any infant male circumcision programme can be considered, an effective comprehensive infection prevention programme must be established to ensure that patients and providers are protected from HIV exposure during the procedure.

As a general rule, a well established management and referral system to specialist surgeons and paediatricians should be put in place before facilities begin to offer EIMC services.

Chapter 6

Anaesthesia for EIMC

Anaesthesia is recommended for early infant male circumcision. A review of studies has shown that infants react to pain and that local anaesthesia can be effectively provided by a dorsal penile nerve block.⁴⁷ The maximum safe dose of lidocaine in infants is 3 mg/kg of body weight. For a 3-kg infant, this corresponds to 0.9 ml of 1% solution or 1.8 ml of 0.5% solution. Anaesthetic solutions containing epinephrine (adrenaline) should never be used.

In Kenya, 2% lignocaine is the most commonly used local anaesthesia preparation, and a dilution chart to convert it to 1% lignocaine has been provided in Chapter 8 and Annex 16 of this manual. Facilities providing EIMC services are encouraged to print out and display this and other relevant annexes attached to this manual as additional job aids/wall charts and display them within their clinics.

For most neonates and young infants, 1 ml of 1% lidocaine without epinephrine can be used by injecting 0.5 ml at the 10 o'clock site and 0.5 ml at the 2 o'clock site at the base of the penis.

Providing pain relief during infant male circumcision is a priority but it must be done in a way that does not endanger the long-term well-being of the infant. Only Local anaesthesia should be used for EIMC.

There are serious risks associated with sedation, which is not recommended for clinic-based circumcision. If sedation is required for the safe performance of the procedure the patient should be referred to an appropriate clinic capable of providing sedation safely.

Safe injection of local anaesthetic

The risks and benefits of providing anaesthesia in any given health-care environment must be evaluated. Significant morbidity and mortality can occur if appropriate precautions are not taken during the administration of any form of anaesthesia.

The injection of a local anaesthetic should only be done in settings where there is reliable access to sterile needles and where institutional protocols have been established to ensure the safe handling and disposal of contaminated sharps.

The EIMC service provider is responsible for ensuring that the facility where injectable local anaesthesia is used has functional mechanisms for handling contaminated sharps and hollow bore needles.

It is the surgeon's responsibility to check the vial of anaesthetic, including the expiry date, and to ensure the sterility of the needle and syringe and that the correct agent and concentration have been selected. It is important to verify that the anaesthetic is clear and that there are no visible particles, which may suggest that the vial is contaminated. The use of single-dose vials has also been recommended as a measure to prevent surgical site infections.⁴⁸

The surgeon should gently aspirate once the needle is in place but before injecting any local anaesthetic and confirm that no blood enters the syringe, in order to ensure that no anaesthetic is injected into a blood vessel. This precaution should be repeated each time the needle is moved and before any additional local anaesthetic is injected.

Dorsal penile nerve block

A 1-ml syringe is used with a 27-gauge or a 30-gauge needle and inserted at the 2 o'clock position at the base of the penis in a posteromedial direction and to a depth of 0.3 and 0.5 cm into the subcutaneous tissue.^{49, 50} Once aspiration demonstrates no blood, 0.5 ml of 1% lidocaine without epinephrine is injected. The needle is withdrawn and this step is repeated at the 10 o'clock position.

Figure 5.1. Cross-section of the shaft of an infant penis. The dorsal nerve, artery and vein run along the dorsal midline. To avoid these vessels, the injection is made laterally at the 10 o'clock and 2 o'clock positions at the base of the shaft of the penis

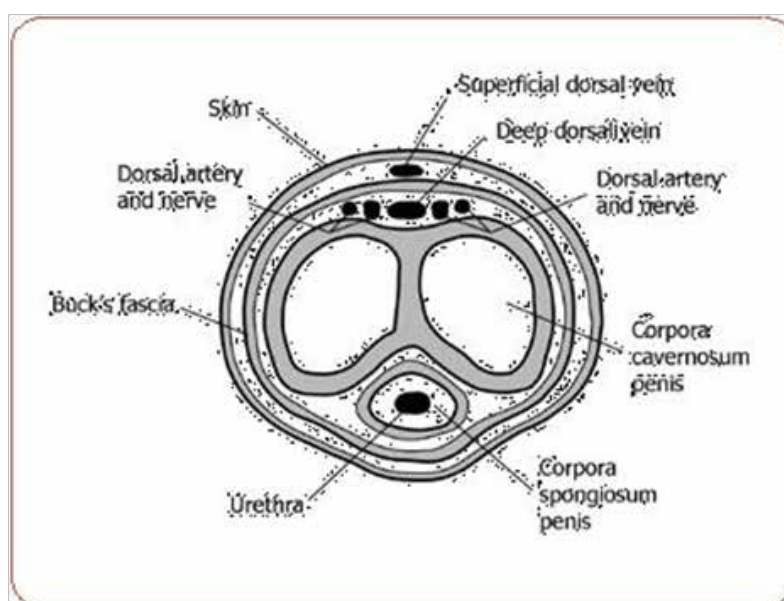

Figure 5.2. Injection of local anaesthetic for a dorsal penile nerve block at the 2 o'clock and 10 o'clock positions at the base of the penis

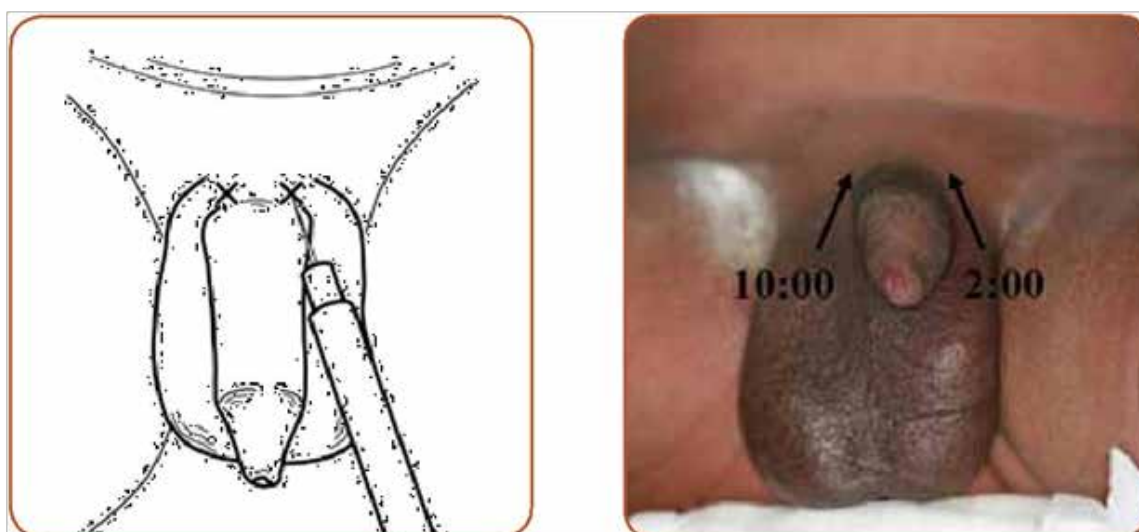

Figure 5.3. Injection of anaesthetic at the base of the penis



The most common complications of dorsal penile nerve blocks are bleeding, bruising, inadequate analgesia and small haematomas. Lidocaine toxicity can be avoided by aspirating before injection. Injection should not be done in the midline so as to avoid injecting directly into a vessel.

The dorsal penile nerve block is the best-described and best-studied technique and has a low rate of minor complications.⁵¹ The ring block has been more recently described but takes longer and requires more needle sticks.⁵² In the only randomized controlled trial comparing the two techniques, 14 infants were enrolled in each arm, and no significant difference in pain perception was noted between the two techniques during activation of the clamp, the step that creates the most significant tissue injury and likely pain.⁵³ At the time of publication of these guidelines, there is insufficient data to determine if one technique is truly superior to the other.

An advantage of the dorsal penile nerve block is that the injection is made at the base of the penis. With a ring block, anaesthetic is injected along the shaft of the penis and can cause distortion of the anatomy, making it difficult for the surgeon to identify the coronal margin and appropriately mark the location of the incision. This is particularly problematic in patients with a short penile shaft. Use of ring block is therefore discouraged.

EMLA cream

EMLA 5% cream (eutectic mixture of local anaesthetics, containing 2.5% lidocaine and 2.5% prilocaine) has been extensively used for Plastibell circumcision in children of all ages.⁵⁴ If used correctly it is safe and provides effective anaesthesia.⁵⁵ It must however be applied with care in neonates, because of the potential risk of methaemoglobinaemia from prilocaine metabolites, which can oxidize haemoglobin (see Annex 5). Care must be taken to ensure that the cream is not rubbed on to a large area of the infant's body, as a result of the hands and feet wriggling during the procedure. This can be done by covering the penis with a small piece of polythene held in place with a sticking plaster. It has been shown that, provided the cream is applied only to the penis, EMLA cream is safe for both term and preterm infants. Possible minor adverse events include transient local skin reactions, such as blanching and redness.

EMLA cream should be applied to the whole penis 60 to 80 minutes before the procedure. Depending on local circumstances, it is often possible for the parent to apply the cream at home before coming to the clinic. If this is done the clinic staff should ensure that the cream has been applied properly.

The maximum recommended doses and duration of exposure to EMLA cream are summarized below in Table 5.1.

Table 5.1. Recommended maximum exposures to EMLA cream in early infancy⁵⁶

Age group	Maximum dose	Period of application
0–3 months	1 g	60–80 minutes

In summary, EMLA cream requires extra precautions and has a longer time lag between application and onset of anaesthetic effect and is therefore not encouraged in Kenya’s EIMC program.

Other options for comfort

Breast milk is a natural and economical way to comfort the baby.^{57, 58} Expressed milk may be applied to a fingered glove or gauze for suckling. Just providing a clean finger to the baby for sucking may also be an effective option for comfort. Data indicates that neonates can be comforted by oral sucrose at 0.05 to 0.5 ml of 24% solution (sugar water) administered 2 minutes before the painful procedure.⁵⁹

Avoid Sedation

There are serious risks associated with sedation, which is not recommended for clinic-based circumcision. If sedation is required in order to perform the procedure safely the patient should be referred to an appropriate clinic capable of providing safe sedation.

In early infancy (<60 days of age), sedation should not be required for the performance of male circumcision and should be avoided because of the serious complications that can develop.

Chapter 7

Choice of Mogen clamp for EIMC in Kenya

The three most widely used surgical devices for early infant male circumcision are Mogen clamp, Gomco clamp and Plastibell. Only Mogen clamp is described in detail here because it is the recommended EIMC device for use in Kenya.

For details on other EIMC devices, refer to the WHO/JHPIEGO manual for early infant male circumcision under local anaesthesia.

Figure 7.1. The three widely used infant male circumcision devices: Mogen (left), Gomco (centre), and Plastibell (right)



Kenyan Surgeons (nurse specialists, clinical or medical officers) should become experts in the Mogen clamp technique which is the nationally recommended technique most suited to the circumstances of their practice. It is not recommended that a surgeon learns all the techniques. It is best to become a master of one technique. This will produce the best results with the least complications.

Reasons for choosing Mogen clamp for Kenya's EIMC program

The following two tables summarize key features and the complications associated with each of three commonly used devices for EIMC which should be considered in making a choice. Based on these considerations Mogen clamp is deemed to be most suited for the prevailing circumstances in Kenya. Consequently Kenyan EIMC service providers will be trained to use only the Mogen clamp. This recommendation may be revised in future if new device(s) with clear advantages over the Mogen clamp become available.

Table 7.1: Considerations for selecting among the three most commonly used Infant Male circumcision devices (shaded areas represent undesirable features that should be taken into account when each technique is being considered for use in a programme)

Consideration	Mogen	Gomco	Plastibell
Single or multiple sizes	Single infant size can be used for all infant males	Various sizes must be available	Various sizes must be available
Number of parts	Single part simplifies inventory	Various sizes and multiple parts complicate inventory	Multiple sizes but a single part simplifies inventory
Sizing errors	Reduced risk One size for all infants (slot size must be checked)	Increased risk (related to mismatching device parts)	Increased risk (complications associated with bell of wrong size)
Duration of procedure	Requires the least amount of time to perform	Requires more time	Requires more time
Use in older infant males and young boys without suturing ¹	Routinely requires closure of the wound in infants >60 days of age	Routinely requires closure of the wound in infants >60 days of age	Routinely does not require closure of the wound, regardless of age
Disposable/reusable	Reusable Requires reprocessing ²	Reusable Requires reprocessing ²	Device itself is disposable (Instruments may require reprocessing)

Table 7.2. Potential complications of the three most commonly used infant male circumcision devices

The highlighted areas represent undesirable features that must be considered.

Consideration	Mogen	Gomco	Plastibell
Bleeding	Similar risk (1.0%)	Similar risk (1.0%)	Similar risk (1.0%) Associated with injury to the frenulum
Urethral injury	Reduced risk	Increased risk	during application of the bell and/or loose ligature Increased risk
	(dorsal slit is not routinely required)	(dorsal slit routinely required)	(dorsal slit routinely required)
Penile laceration/ amputation	Increased risk (glans may not be protected)	Increased risk (related to mismatching device parts)	Reduced risk
Urinary retention, bladder rupture, injury from retained parts	No risk (no retained parts)	No risk (no retained parts)	Increased risk if bell of wrong size is used, as it can slip back on to shaft of penis, causing gangrene, urinary retention and bladder rupture
Buried glans	Increased risk if surgeon does not free glans	Similar risk	Similar risk
Other comment	Penile amputations can occur even under ideal circumstances	When matching non-defective parts are used there is essentially no risk of injury to the glans	Complications from retained parts can occur even under ideal circumstances

Chapter 8

EIMC using Mogen Clamp

Mogen clamp is the nationally recommended device for EIMC in Kenya. Therefore, all EIMC service providers should master the Mogen clamp technique. This will produce the best results with the least complications.

Mogen (Bronstein style) clamp: technique

Step 1:

Ensure that the clamp is the correct size and in good working order. Although there is only one standard infant size, Mogen clamps exist in different sizes with varying gap distances to accommodate older males with thicker foreskins. The Mogen clamp with a gap distance of 2.5 mm is designed for infants. Clamps of larger size with a gap distance greater than 2.5 mm have been associated with more frequent penile amputations in infants and should be removed from any area that performs infant male circumcision so that they cannot be inadvertently used by an unsuspecting provider.^{90, 91} The edges of the jaws should be routinely inspected to ensure that they are not dented or chipped. Because the clamp is rigid, any defect that prevents approximation of the edges will prevent adequate crushing.

Step 2:

Weigh the baby and record weight in Kg (Weight in kilogrammes is plugged into a standard formula for calculating the amount of injectable local anaesthetic for the baby). Confirm that the baby's weight is normal for age.

Step 3:

Use a 5ml syringe to draw 2.5 ml syrup of Panadol to be given to the baby before the procedure (this can be administered by the mother)

Step 4:

Wear clean gloves when positioning the infant in a well-lit warm area on a comfortable surface. Lay the baby on EIMC board and restrain him. Use the mothers "leso" or shawl for head support. The infant may also be restrained by an assistant. Other means of restraint are to swaddle the arms and chest with a blanket or towel or to have another health-care worker gently holding the arms and chest of the infant. The baby's head and mouth should never be covered and he should be continually monitored to minimize any discomfort during restraint. If a restraint board is used, it can be helpful to prop up the top so that the infant is not lying flat on his back. A blanket can be placed between the infant and the restraint board for comfort and soft velcro straps can be used to gently restrain the infant. The perineum should be exposed and cleaned with moist wipes. A fresh nappy can be tucked under the baby and left open.

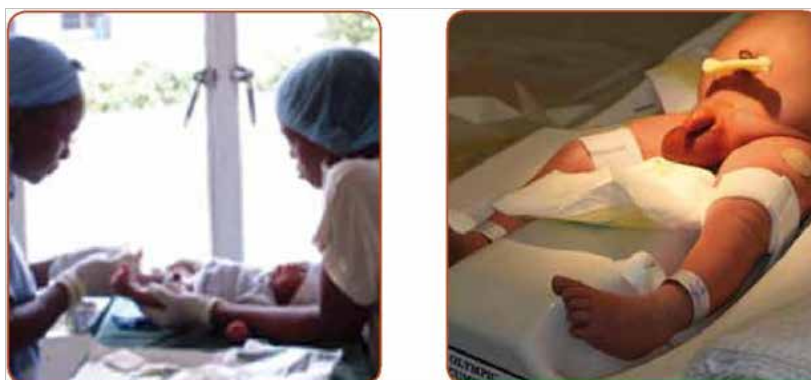

Step 5:

Note that only 2% lignocaine injection is readily available in Kenyan market

Use insulin needle and syringe to draw lignocaine 2% solution for dilution to make 1 ml of 1% solution as follows:

- Volume of 2% lignocaine to be drawn= Wt. of baby in Kg x 0.15= xml
- Draw xml of 2% lignocaine solution into the diabetic syringe
- Top this to one ml by drawing water for injection into the same syringe
- Use alcohol swabs to clean the two sites to be infiltrated with LA at the base of the penis (10 and 2 o'clock)
- Inject local anesthetic (0.5ml 1% lignocaine at 10 O'clock and 2 O'clock positions round the base of penis each side for dorsal nerve block) then continue preparation for 5 minutes as the anaesthetic takes effect

Weight (kg)	Max dose 2% Lignocaine - ml	Water for Injection - ml	Total Volume in Syringe - ml
2.5-2.9	0.35	0.65	1.0
3.0-3.4	0.45	0.55	1.0
3.5-3.9	0.5	0.5	1.0
4.0 - 4.4	0.6	0.4	1.0
4.5 - 4.9	0.65	0.35	1.0
5.0 – 5.4	0.75	0.25	1.0
5.5 – 5.9	0.85	0.15	1.0
6.0 – 6.4	0.9	0.1	1.0

Step 6:

Remove clean gloves and put on sterile gloves

Open sterile EIMC pack and verify that it has the following (2.5mm size Mogen clamp opening only up to $\frac{3}{4}$ of the way with no dents or chipped edges at the jaws, 3 straight artery forceps, 7 pieces of 4x4 sterile gauze, gully pot, surgical blade)

Pour 5ml of povidone iodine into the gully pot. Soak 2 pieces of sterile swabs with the iodine solution and use these to clean the penis including 2.5 cm of skin round its base

**Step 7:**

Cover the operation site with a fenestrated drape (with a hole at the center) allowing exposure of the penis



Step 8:

Grasp the foreskin with two straight or curved haemostats (artery forceps) at 3:00 and 9:00 (ensure that the haemostats have a firm grasp on the foreskin by ensuring that at least 4 teeth are holding the tissue).

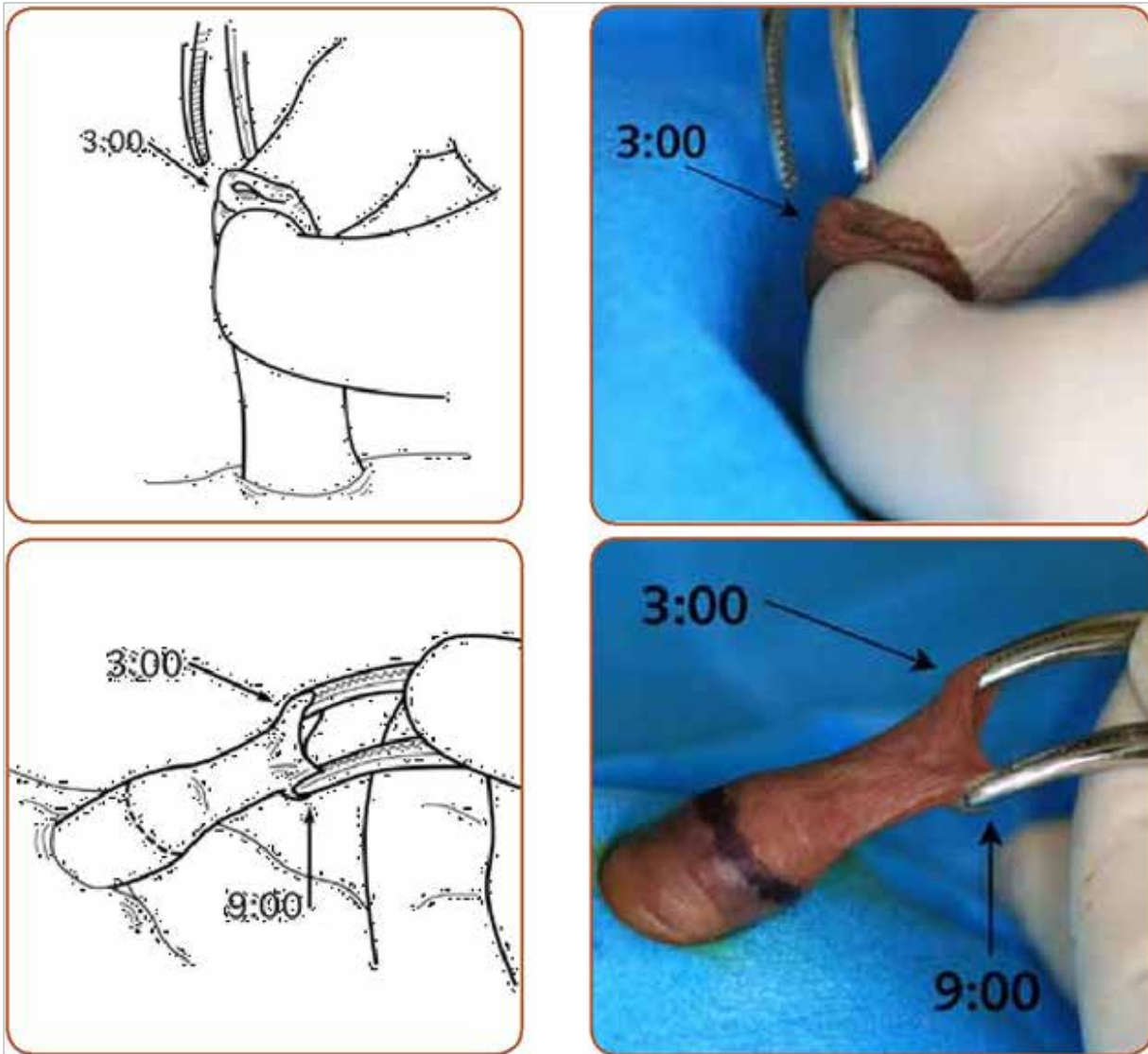
**Step 9:**

Apply gentle traction on the foreskin using two haemostats in step 8 above and introduce a blunt probe (plastic or metal) to break any adhesions between the glans and the inner mucosal layer of the foreskin. Using the probe in an up-and-down motion parallel to the frenulum when breaking adhesions in the ventral area reduces the risk of injury to the frenulum which can lead to bleeding.

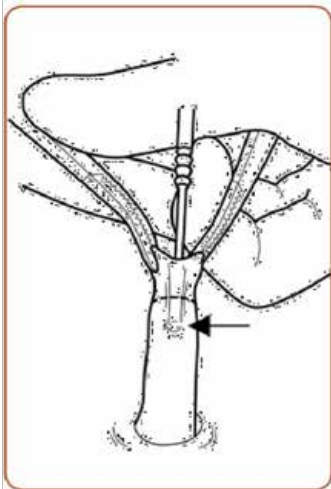
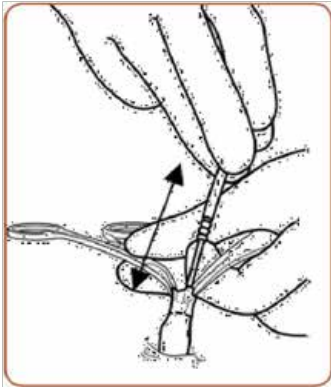

A straight haemostat can also be used to remove adhesions



Step 10:

During the process of breaking adhesions, the foreskin opening will naturally dilate to some extent. Further dilatation of the foreskin to allow complete retraction of the foreskin can be achieved by firmly stretching the foreskin outlet using a hemostat.

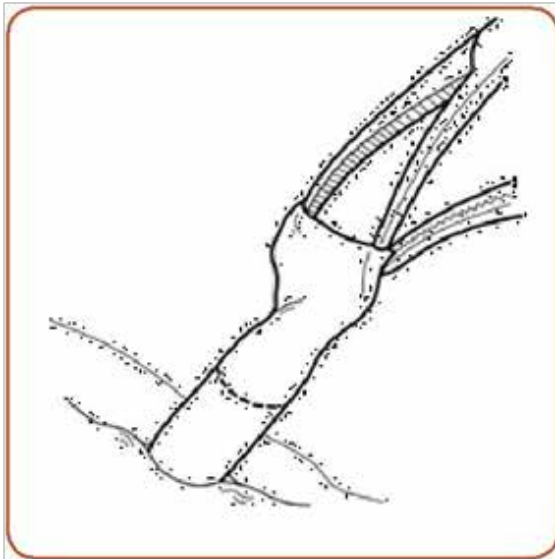

Step 11:

After the opening has been firmly dilated, retract the foreskin to expose the corona. This allows inspection of the glans. Any residual adhesions can be removed with a blunt instrument or a gauze pad. This also helps to verify the absence of hypospadias.



Step 12:

A third hemostat is used to determine the line of circumcision without using a skin marker. It is opened and introduced at 12 O'clock up to junction of the foreskin and the corona while the foreskin is gently held using the two hemostats at 3:00 and 9:00 positions. The third hemostat is pulled back by 1-2 mm then closed. Its tip will be at the circumcision line.

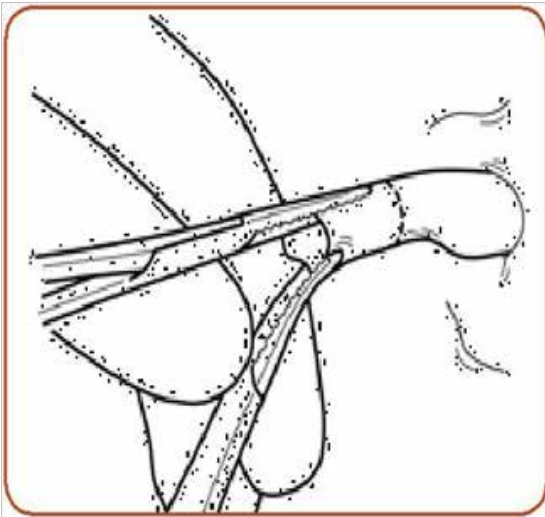
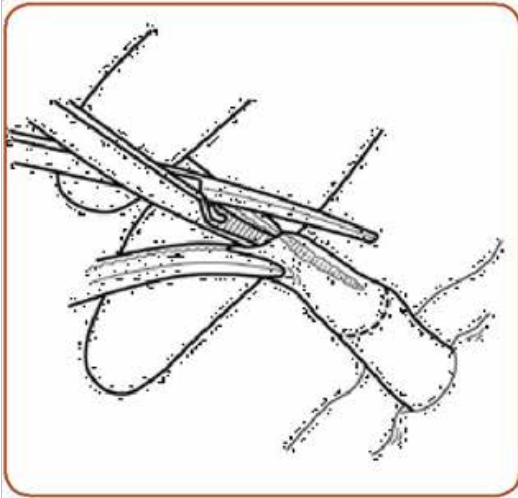

Step 13:

Apply traction on the foreskin, and introduce it into the slit in the Mogen clamp, guided by the dorsal haemostat, with the concave side facing the glans and the flat surface facing the foot of the baby. Ensure that the glans is not pulled into the slit. If there is any doubt, remove the clamp, inspect the glans for any sign of crushing injury and reapply the clamp. Place the long axis of the clamp parallel to the frenulum along the dorsal-ventral axis of the penis at 45 degrees. To protect the glans, the non-dominant index finger and thumb are used to pinch the foreskin together from the ventral side to the dorsal haemostat, the handle of which is held in the palm (Figure 8.2). Traction is then applied along the axis of the penis. The first manoeuvre retracts the glans out of the way. The Mogen clamp is then slid across the foreskin, starting at the tip of the haemostat and angling distally as it approaches the ventral side. The foreskin that remains above the clamp should be wedge-shaped, with more length dorsally than ventrally.⁹³

Pinch the foreskin between the index finger and thumb, pushing the glans down and out of the way in preparation for aligning the foreskin tissue in the Mogen clamp

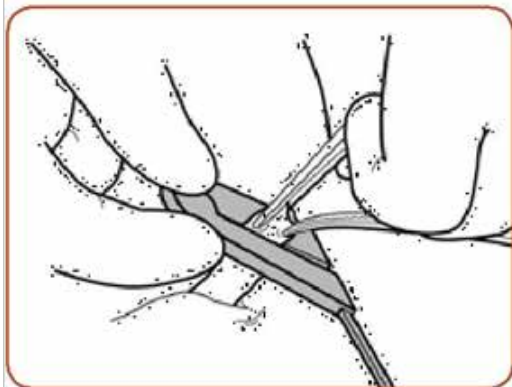
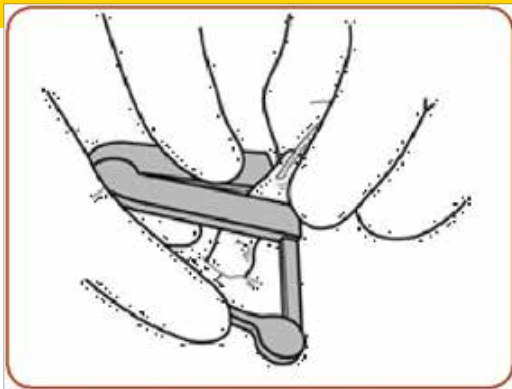

Step 14:

Once the provider is sure that the glans is safely below the clamp, it is closed and activated using the lever arm, crushing the foreskin (this action is also referred to as activation of the clamp). To reduce the risk of bleeding, the clamp should remain closed for 5 minutes.

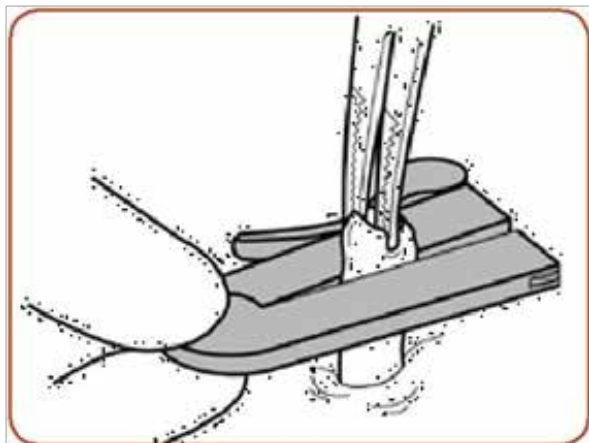

Step 15:

Excise the foreskin with a scalpel by using the outer flat side of the clamp as a guide. After allowing a 5-minute crush time, release the lever arm, open the device, and remove. The Mogen clamp is designed to protect the glans, which remains below the clamp.

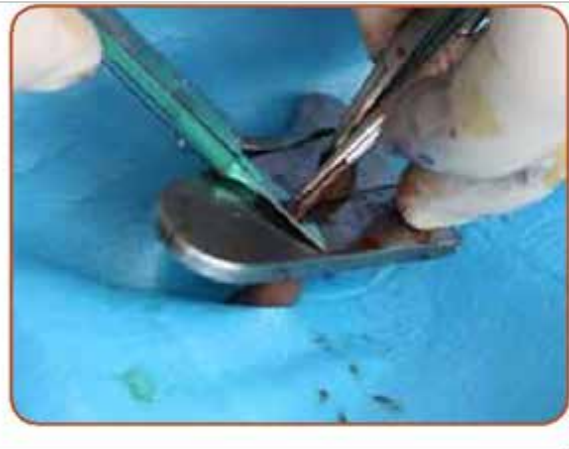
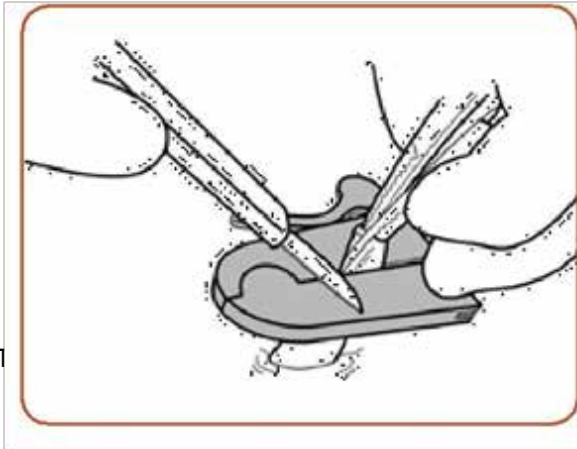

ead

Step 16:

Manipulate the penis, using gentle pressure from the side, to allow the glans to emerge from under the crushed foreskin. This is an important step to ensure that the foreskin heals below the level of the corona.

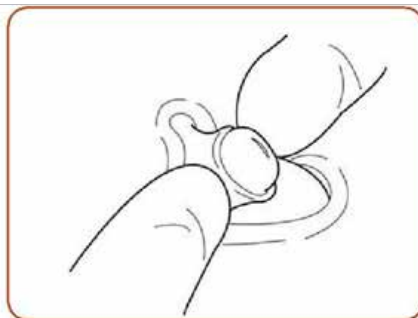
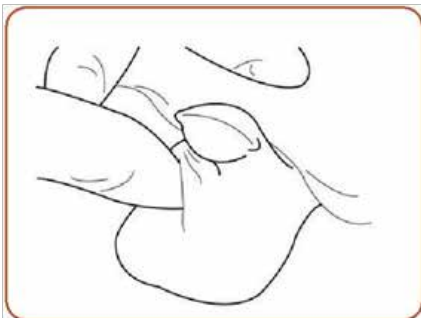

Step 17:

Inspect for bleeding then apply petroleum jelly over the glans and the wound. Gently cover the glans and the wound with sterile gauze pad impregnated with petroleum jelly on the inner aspect. There is no need for strapping. The mother is given 4 gauze pads and 120 grams of the petroleum jelly to use for replace dressing after three hours or each time the baby passes urine over the next 12-24 hours. Dry baths is advised for 4 days. Mother is advised to bring baby for review after 3 days (for instance, the baby to be reviewed on Thursday if procedure is done on Monday).

In case of bleeding (Vitamin K and 4.0 catgut are in the emergency tray)

- Apply sustained gentle pressure with gauze for 3-5 minutes
- If bleeding persists and is generalized round the wound the give IM Vitamin K 1000 IU in addition to sustained pressure.
- If bleeding is localized from a blood vessel, then control it by suturing with 4.0 chromic catgut on a round body needle

Mogen circumcision two weeks postoperatively



Mogen (Bronstein-style) clamp: device-specific complications

The most significant device-related complication associated with the Mogen clamp is distal tip penile amputation.

Figure 8.10. Partial glandular amputation following infant male circumcision

This extremely rare complication can be minimized by using good surgical technique but is unlikely to be eliminated. Unfortunately, even under ideal circumstances and with experienced surgeons this complication may occur.^{94, 95}



Risks associated with this device can be minimized by exercising the following precautions:

- the clamp must be properly sterilized before each use;
- the clamp should be inspected for any defects and the gap distance should not be greater than 2.5 mm;
- the clamp should only be applied if the foreskin can be freely separated from the glans. If the glans is not separated from the foreskin it can be inadvertently pulled into the clamp and excised;
- use a surgical mark and ensure that the foreskin is symmetrically aligned before activating the clamp.

Chapter 9

Postoperative care

Good postoperative care is extremely important for ensuring the best outcome.

Postoperative dressing

One of the complications of male circumcision is the possibility of developing a surgical site infection. Strong evidence exists that protecting a postoperative incision with a sterile dressing for 24 to 48 hours can help to prevent surgical site infections.^{107, 108} The WHO guidelines for safe surgery also recommend that a sterile dressing be applied over a surgical wound for the first 24 to 48 hours to help prevent surgical site infections.¹⁰⁹

The most important elements of a circumcision dressing are to protect the wound, help control bleeding and oedema, allow for monitoring of bleeding, and allow the passage of urine.

Figure 9.1. Examples of a poorly applied dressing (left) and an acceptable dressing (right)



The dressing on the left may obstruct urine flow and is poorly applied to the wound. The dressing on the right allows visualization of the glans, does not obstruct urine and is well applied to the wound, protecting it from contamination and reducing oedema and bleeding risk.

The method of applying this type of dressing is illustrated below. More detailed instructions, including photographs showing each step, are provided in Annex 10.

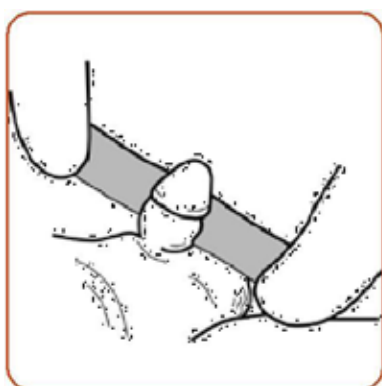

1



2



3

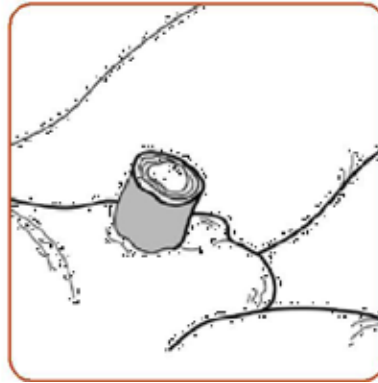

4

Step 1: Fold gauze to create long narrow dressing and impregnate with petrolatum (petroleum jelly).

Step 2: Wrap gauze around the penis, crossing the two ends.

Step 3: Pull gauze ends until dressing is snugly applied to the wound.

Step 4: Wrap the remainder of the dressing neatly around the penis.

To ensure that the dressing is not too tight, the penis should be squeezed to check that it is still compressible. The dressing should be applied snugly but should not restrict the flow of blood and urine through the penis. One of the advantages of this dressing is its ability to help control bleeding and minimize the need for more aggressive surgical intervention. The dressing should remain in place for 24hours, during which time bleeding and urine output should be closely monitored. If the dressing falls off and there is no significant bleeding, another dressing does not need to be applied and petrolatum should be applied to help protect the wound and keep it from sticking to the nappy/diaper.

There have been isolated case reports in the literature describing urinary obstruction from dressings that have been left in place for more than 7 days.¹¹² Clear instructions must be provided to monitor bleeding and urine output and to remove the dressing 24hours after its application. To remove the dressing it should be moistened and gently unwrapped. Some minor bleeding that can occur when the dressing is removed should be managed with simple direct pressure.

Postoperative care instructions

A postoperative information sheet is provided in Annex 10. This should be given as a handout for family or carers. The precautions in the handout should be reviewed in detail with the family of the infant before discharge from the clinic or hospital. The family should be instructed to return to the health clinic for any of the following reasons;

General precautions

- The infant appears to be distressed or in pain.
- The infant is cries a lot/ is irritable/ inconsolable.
- The infant is lethargic.
- The infant has hotness of the body/ fever.
- The infant does not wake for feeding in accordance with his usual pattern.
- There is any separation of the skin edges.
- There is any unusual swelling or bleeding.
- There is a discharge or foul smell associated with the wound
- The infant has any difficulties with urination.
- The family has any other concerns.

Mogen-Clamp specific precautions

- The dressing must not be left on for longer than 48 hours.

Chapter 10

Possible Postoperative complications

Though rare, a number of complications may follow the circumcision procedure. Providers and families must be able to recognize and address postoperative complications.

Immediate postoperative complications

Post-circumcision bleeding

Most episodes of post-circumcision bleeding can be addressed by simply applying an appropriate dressing as described in Annex 11. In the event of continued bleeding, direct pressure should be applied with the dressing in place. After 5 minutes of pressure the dressing can be released and the baby observed.

If bleeding persists, the dressing should be removed and the wound closely inspected. Other causes of bleeding, including a clotting disorder and/or an occult injury, should be considered. If the bleeding is minor and localized another dressing can be applied and accompanied by 10 minutes of direct pressure, measured by the clock.

If bleeding persists despite these measures, surgical and medical consultation should be considered. A post-circumcision bleeding protocol is provided in Annex 12. It should be posted on the wall in the procedure room and in units caring for infants with a circumcision wound. Such a protocol will minimize the need for surgical intervention and its associated complications. The protocol focuses on direct pressure and patience, representing the most effective, least expensive and universally available intervention.

Vitamin K at a dose of 1 mg given intramuscularly shortly after birth has been shown to reduce bleeding after neonatal circumcision.^{114, 115} In Kenya this is recommended but not is routinely given to all neonates. Routine administration of Vitamin K to newborns should be promoted at all facilities implementing EIMC.

Application of simple direct pressure and an appropriate dressing should be the mainstay for treatment of bleeding after infant male circumcision.

In extremely rare circumstances during infant male circumcision there may be need for suturing. The rarity of this complication means that, for some providers, surgical consultation should be obtained without attempting to suture or close the wound. An overview of suturing and wound closure is provided in Annex 9 but is suggested only for those providers who have experience of suturing and closing wounds. All other providers should obtain immediate specialist consultation.

Too little skin is removed

There will inevitably be cases where an error is made in determining the amount of foreskin to remove. This is one of the least serious complications, as more tissue can always be removed later. In these cases the wound should be cared for in the usual manner and the family should be reassured that once the wound heals the procedure can be redone if necessary. The body has a remarkable propensity to heal: frequently, by the time the wound has healed, the outcome is satisfactory. If a revision is necessary the procedure should be delayed (if possible) until after 6 months of age and scheduled with a provider skilled in performing infant male circumcision revisions.

If insufficient foreskin is removed the wound should be allowed to heal before any further intervention. An immediate secondary procedure to remove more foreskin tissue can be complicated and is strongly discouraged.

Too much skin is removed (degloving)

In mild cases and without significant bleeding the wound can be managed conservatively and will heal reasonably well through secondary intention. Another reasonable approach would be to close the wound with simple interrupted sutures.

Figure 10.1. An example of degloving immediately following male circumcision (left), and the same wound three weeks postoperative with healing occurring through secondary intention (right)



Figure 10.2. An example of degloving immediately following a Mogen male circumcision



The severity of this injury warrants specialist consultation.

Figure 10.3. An example of degloving following male circumcision



The wound is being closed with simple interrupted sutures.

In severe cases, or if the surgeon has any concerns, the baby should be referred for immediate specialist consultation.

Injury to penis or surrounding structure

Don't panic and don't try to hide the injury. Most injuries can be successfully repaired without any significant long-term consequences. However, the injuries must be addressed early. Basic first aid should be administered. Once the injury is identified the bleeding should be controlled by applying direct pressure on the wound, using a moist dressing. Any injury to the penis or a surrounding structure should be evaluated by a specialist. While consultation is being arranged the infant should be made comfortable and the wound should be closely monitored for bleeding.

If an injury occurs to the penis or to a surrounding structure, immediate specialist consultation should be arranged.

A thin mucosal layer is not excised

In the early infant foreskin the outer keratinized skin is tightly adhered to the very thin inner mucosal tissue.

Figure 10.4. A piece of removed foreskin showing the inner mucosal membrane



In the infant penis this thin membrane is tightly adhered to the outer keratinized skin and cannot be easily dissected and separated from the outer tissue.

Under unusual circumstances this thin membrane can be separated from the outer skin. This may occur more commonly when a dorsal slit is made, allowing a point of entry between these two tissue planes. If a shielding device is placed in this potential space the possibility exists that, following excision and removal of the clamp, the thin mucosal membrane remains intact. In most of these cases the mucosal layer will be tightly adhered to the glans. The thin membrane can be teased away from the glans with gauze or a blunt instrument. In many cases, during this blunt dissection alone, the thin connective tissue will retract and no further intervention will be required. In some cases this membrane may be thick and require excision. Because this mucosal tissue avoids being crushed, special attention should be given to any bleeding after its excision.

As a general rule, a well established management and referral system to specialist surgeons and paediatricians should be put in place before facilities begin to offer EIMC services.

Other postoperative complications

Reactions to anaesthetic agent

If an infant appears to be having a reaction to the anaesthetic agent, immediate specialist consultation should be obtained to help manage the problem.

Pain

Acetaminophen (paracetamol) has been suggested for treating postoperative pain associated with infant male circumcision.

Infection

Normal wound-healing must be understood so that a true infection can be identified and treated. To the untrained eye a completely normal circumcision wound could look infected. It is normal for a circumcision wound to have a thin yellow film, which can easily be mistaken for pus. One distinct difference is that this yellow film cannot be easily removed. Pus, which is not normal, can typically be easily wiped away with a moist wipe.

During the first 48 hours, infection is rare and the wound looks its worst, with inflammation, redness and tenderness. This is normal. After 48 hours the wound should look better, but if it starts to look worse and is accompanied by more swelling, redness, pain or frank pus, a wound infection should be seriously considered. Fever, poor feeding, decreased urine output (reduced number of wet nappies/diapers) or an infant that is inconsolable or lethargic should immediately raise concern for systemic involvement.

In the event of a wound infection the infant should be evaluated for possible sepsis and other complications and treatment should begin immediately.

Urine obstruction

For any suspicion of urine obstruction the dressing should be removed immediately. Another cause of urine obstruction following male circumcision is the placement of ventral sutures, which may penetrate the shallow urethra and cause occlusion. Specialist consultation should be considered.

Adhesions

Adhesions that form between any residual foreskin and the glans can be reduced over time by carefully wiping and pushing the foreskin back away from the glans. Without any intervention, most of these adhesions will resolve spontaneously during adolescence under the influence of androgens. Only rarely will adhesions involve the circumcision wound and require subsequent surgical intervention.¹¹⁶

To help avoid adhesions the family can be instructed to gently retract the penile skin at each nappy/diaper change to ensure that no adhesions develop on to the glans or corona. Many providers also suggest the liberal use of petrolatum (petroleum jelly) to create a barrier between the two surfaces.

Figure 10.5. Adhesions following infant male circumcision



Fusion

To help prevent preputial glandular fusion it is important to maintain a barrier between the circumcision wound and the de-epithelialized areas on the glans where adhesions were removed. This can be achieved through the use of a dressing or the liberal application of petrolatum.

Trapped penis

The complication of a trapped penis can occur even if the perfect amount of foreskin is removed. To help prevent this complication it is important to ensure that the healing wound stays beneath the level of the corona.^{117, 118} If the wound begins to contract above the level of the corona the glans can be pushed down beneath the contracting scar and appear to be buried. This complication can frequently be managed with the application of topical steroids, which can help to reduce the scar and allow the glans to resume its normal anatomical position.¹¹⁹

Figure 10.6. Trapped penis in an infant following male circumcision



The healing wound has contracted over the glans, causing it to become hidden.

Figure 10.7. Trapped penis in an adolescent male following circumcision



The healing wound has contracted over the glans, causing it to become hidden.

Figure 10.8. Redundant skin in an infant following male circumcision



This can be difficult to differentiate from a buried/concealed penis and should be evaluated with specialist consultation

The glans is partially covered by the foreskin

During the first year of life it is common for the glans to become partially covered with penile skin as a result of a prominent suprapubic fat pad. This may be disconcerting to family members but typically resolves during normal development after the first year of life. Appropriate education must be provided at the time of surgery to avoid inappropriate post-procedural expectations and disappointment.



A fibrotic scar forms over the urethral opening.

Skin bridge

During healing it is important to isolate the surgical wound from wounds on the glans, where the epithelial layer may have been disrupted during the removal of adhesions.

Figure 10.10. Skin bridge



Chapter 11

Standard precautions and instrument processing

Overview

- Health-care workers should follow recommended practices for preventing infection in order to protect themselves, other health-care workers and their patients from exposure to HIV and other infections.
- Hand hygiene greatly reduces the number of disease-causing microorganisms on the hands and arms. It is the most important way of limiting the spread of infection.
- The hands should be washed with soap and water after each patient/client has been seen; otherwise, an alcohol-based hand-rub should be used. (Facilities should provide the hand washing SOPs or job aids)
- Appropriate personal protective equipment should be worn to protect both clients and staff from infectious microorganisms.
- Sterile gloves should be worn during early infant circumcision procedures or when performing any other invasive procedure. A new pair of gloves should be worn for each new client contact in order to avoid spreading infection from person to person.
- All staff should be trained in the proper handling of sharp instruments. Hypodermic (hollow-bore) needles can cause injuries to clinic staff at all levels: health care workers can be stuck by hypodermic needles during patient care, cleaning and housekeeping. Staff may be exposed to needle-stick and sharps injuries when washing soiled instruments and disposing of infectious waste material. (SOPs for handling sharps to be displayed at each facility)
- Clean or heavy-duty (industrial) gloves should be worn by staff when handling contaminated items.
- Instruments and other reusable items can transmit disease if not properly decontaminated, cleaned, sterilized or subjected to high-level disinfection. Sterilization destroys all microorganisms, including bacterial endospores. High-level disinfection destroys all microorganisms, except some bacterial endospores.
- Proper waste management is important for preventing accidental injury to people who handle waste items and for preventing the spread of infection to health-care workers and the local community.
- Post-exposure prophylaxis (PEP) for HIV with antiretroviral drugs may reduce the risk of infection after exposure to HIV. It will be effective only if it is started immediately within 72 hours after exposure and if the full course of treatment is adhered to. (refer to the Kenya National ART Guidelines and other PEP SOPs on site)
- Post-exposure prophylaxis for hepatitis B with immune globulin can reduce the risk of hepatitis B infection. Consideration should be given to vaccinating all workers against hepatitis B.

Basic concepts

Measures to prevent infection in male circumcision programs have the following primary objectives.

- To prevent infections in people having surgery.
- To minimize the risk of transmitting HIV and other infections to clients and health-care staff, including cleaning and housekeeping staff.

In male circumcision programs a major concern is the potential transmission of blood borne pathogens, such as HIV and hepatitis B virus, to health-care workers or patients. The risk of acquiring HIV from a HIV-infected person through a needle-stick injury is estimated at 0.3% (3 HIV infections for every 1000 injuries). The risk of acquiring hepatitis B virus infection, after being stuck with a needle that has been used on a person with hepatitis B infection, ranges from 6% to 37%, with an average of 18%. Finally, the risk of acquiring hepatitis C infection after being stuck with a needle that has been used on a person infected with hepatitis C is 1.8%. Most instances of transmission of infection in health-care facilities can be prevented through the application

of standard precautions (this will be provided at each site). In the circumcision clinic, standard precautions, as described below, should be applied to all clients at all times, regardless of their infection status.

Standard precautions

Standard precautions are practices aimed at preventing and controlling infection. They include the use of personal protective equipment (defined and available at the site), designed to protect health-care workers and patients from contact with infectious agents. (SOP/Job aids available on the walls).

- The minimum requirement is that providers should wash their hands with soap and water or use a hand-rub after each patient has been seen.
- Alcohol-based hand-rubs do not remove soil or organic matter. Washing with soap and water is recommended between the use of hand-rubs.
- Staff who frequently wash their hands or use an alcohol-based hand-rub should use hand lotions and creams regularly in order to minimize drying of the skin and reduce the risk of irritant contact dermatitis. Staff with an allergy or adverse reaction to alcohol-based hand-rubs should use other hand-rubs or soap and water. If potentially infectious blood or other body fluid is splashed on to non-intact skin, or if there is a potentially infective percutaneous injury, do not use alcohol-based solutions or strong disinfectants but wash the affected part with water and soap, and seek advice on the need for post-exposure prophylaxis.

Surgical hand scrub

The use of surgical hand scrub is recommended at the beginning of the first procedure of the day and whenever the provider comes back to the procedure room after leaving, e.g. after lunch or after use of the bathroom.

Personal protective equipment

Personal protective equipment (PPE) provides a physical barrier against microorganisms, helping providers to prevent the contamination of hands, eyes, clothing, hair and shoes, and the transmission of infections to patients and other staff. PPE includes gloves, masks, protective eyewear (face shield or goggles), cap or hair cover, apron, gown and footwear (boot or shoe covers). PPE should be used by health-care workers who provide direct care to patients, support staff including medical aides, cleaners, laundry staff and family members who provide care to patients. The ensemble of PPE worn by staff should be appropriate to the level of potential exposure (to both staff and patients). Reusable PPE (e.g. plastic aprons) should be decontaminated according to the manufacturer's instructions or laundered according to the protocol of the health-care facility. For early infant male circumcision procedure the following PPE is recommended.

Gloves: The use of gloves does not replace the need for hand hygiene by either hand-rubbing or hand-washing. Gloves should be worn during and after caring for a patient. Gloves should not be reused to provide care to more than one patient.

Masks (optional): Masks protect the mucous membranes of the mouth and nose from possible infections, as well as reducing the risks of transmission of infections from the health-care worker. They should be worn by anyone undertaking a procedure that is likely to generate splashes of blood, blood products and body fluids. Surgical masks are designed to resist fluids, and are preferable to cotton or gauze masks. The use of masks is optional as their benefit during minor procedures is questionable.

Aprons and the surgeon's gown: Aprons made of rubber or plastic provide a water proof barrier to keep contaminated fluids off the health worker's clothing and skin. Staff should wear aprons when cleaning instruments and other items used for patient care.

Immunizations

Certain vaccines, e.g. hepatitis B vaccine, can be useful in protecting health-care workers against diseases that they may be exposed to during their work. Follow the protocols of health facilities' regulations on immunization.

Safe handling of hypodermic needles and syringes

All clinic staff should be trained in the safe handling of sharp instruments. Hypodermic (hollow-bore) needles are the most common cause of injuries to all types of clinic workers (the health facility should provide sharps boxes).

- Health-care workers are most often stuck by hypodermic needles during patient care.
- Cleaning staff are most often stuck by needles when washing soiled instruments.
- Housekeeping staff are most often stuck by needles when disposing of infectious waste material.

Tips for the safe use of hypodermic needles and syringes:

- Disposable needles and syringes must be used only once;
- Do not disassemble the needle and syringe after use;
- Do not bend or break needles before disposal;
- Dispose of needles and syringes together in a puncture-resistant container. More detailed information on injection and equipment safety is found in Annex 18 of this Manual

Chapter 12

Monitoring and Evaluation

Background

Early infant male circumcision (EIMC) services is part of Kenya's VMMC programme, which aims to curb the spread of HIV infections by increasing access to safe and voluntary male circumcision services. Early Infant Male Circumcision is part of the long term or sustainable phase of the VMMC programme . EIMC services will be integrated into the MNCH service delivery models.

A number of M&E and research approaches will be used to gather data and information necessary for EIMC programme monitoring and improvement. These include routine monitoring, Formative Evaluation, Mid Term Evaluation/Review, Impact Assessments and special studies. However, this manual will only cover the routine monitoring needs of the program. Evaluation and special study designs will be handled on a case by case basis and are beyond the scope of this manual.

Objectives

The purpose of this section is to;

- Define the documentation needs and indicators for reporting on EIMC based on the Clinical Manual for Early Infant Male Circumcision Under Local Anaesthesia in Kenya
- Present Monitoring and Evaluation tools for EIMC.

Program monitoring

Monitoring refers to the ongoing, routine collection, analysis and utilization of priority information on the activities and operations, and planned programme outcomes. The information generated will help determine whether the programme activities are being implemented as intended and achieving the intended programme objectives. Two types of monitoring approaches will be used for the Kenya EIMC program:

- 1) Implementing partners will put in place programme monitoring systems to routinely collect specific input and output data to assess whether targets are being achieved efficiently, and to assess whether the program is on track. The information will also be used to make modifications as needed. Partners will collect all necessary input and output data for their own use and to address reporting requirements of their funders as needed. Only specific output indicators will be reported to NASCOP on a monthly basis: These include:
 - a. Number of staff trained to provide EIMC services. This will include name, cadres and location of each staff trained
 - b. Number and names of all facilities providing EIMC services

This information will be reported parallel to the HIS reporting and will be pooled in a central location at NASCOP and reviewed regularly. Implementing partners will extract the information from the program reports and no separate tools will be developed for this purpose.

- 2) Monthly aggregates will be extracted from the register and included in facility monthly summary and onward submission to the sub county office where they will be entered into the DHIS. Monthly aggregation will apply to the following indicators:
 - a) Number of infants circumcised.
 - b) Type of procedure done. Number of Adverse Events by severity (Moderate, Severe).

These indicators will enable the county and national governments to monitor the uptake as well as safety of EIMC and facilitate actions to promote uptake and maintain safety.

Tools for M&E

The following tools will be used for proper documentation of services provided and for collecting, collating and reporting for EIMC

- 1) EIMC Consent form (Annex 7): This form will be used to document that the parent/Guardian has been given the full information about EIMC, including risks and benefits, all possible options, have been given adequate opportunity to ask questions, questions have been clarified and the parent/guardian has voluntarily agreed for the child to undergo EIMC. It will have the signature of the parent and the service provider who took the parent through the consenting process as well as signature of a witness in case the parent is unable to read or write. The consenting process is fully discussed in Chapter 3 of these guidelines.
- 2) EIMC Client Assessment and Procedure Form (Annex 6). This form will be used to record the assessment before the procedure is done and a verification that the child was in good health and qualified for EIMC. It will also be used to document the circumcision procedure and record any complications or adverse events that happen intra-operatively. It has a provision for follow up.
- 3) Adverse Events Form (Annex 8). There will be a separate Adverse Events form to be used to record in detail all adverse events rated as moderate or severe and the details of treatment and management given. It should also be indicated whether or not adverse events are related to the procedure.
- 4) Register (Annex 13): will be used to list all procedures sequentially by date. It will include child and parent's details as well as the outcomes of the procedures, any AE during the procedure and management given. It will also contain the initials of the health staff performing the procedure

All the records above for each client will be included in the child folder and kept in a lockable cabinet within the facility where services are offered. In addition, an electronic database based on the client records – except the consent form, will be maintained by the implementing partners, with a copy sent to NASCOP.

- 1) Facility Monthly Summary Form (Annex 14). This will be used to aggregate monthly summary and send to the office of Sub County Health Records and Information Officer for entry into the District Health Information Software (DHIS). Facilities with computer, requisite software and rights will enter their summaries directly into the DHIS. The monthly summary form be maintained and completed by the facility-in-charge. EIMC indicators for inclusion into the monthly summary will be extracted from the register and will apply to the following indicators:
 - a. Number of infants circumcised.
 - b. Type of procedures done.
 - c. Number of Adverse Events by severity (Moderate, Severe).

Annex 8 contains definitions of all items in the EIMC Client Assessment and Procedure Form.

Goal: The goal of the EIMC programme is to reduce the incidence of HIV through the contribution of early infant male circumcision.

Objective: The specific objectives of the Kenya EIMC programme are as follows:

- To integrate early infant male circumcision into MNCH care services.
- To ensure all level 4 and level 5 facilities have human capacity and equipment to perform EIMC

Indicators for monitoring EIMC

The following are the main indicators that will be used to monitor the implementation of the EIMC program:

- the number of early infant male circumcision centres/clinics set up in the past year;
- the number of providers trained in early infant male circumcision in the last 6 months;
- the percentage of early male circumcised infants who have developed adverse events (AEs), stratified by severity of AEs;

Chapter 13

Early Infant Male Circumcision service delivery and programme Management

To be effective, the Kenya early infant male circumcision programme will need strong coordination at both the management and service delivery levels. This will help public and private facilities to provide safe male circumcision service of high quality, integrated with the MNCH services and other circumcision service delivery outlets.

Service delivery planning and management

In order for the country to provide early infant male circumcision services, resources, including staff, supplies, client mobilization and health care infrastructure will need to be put in place. The key elements of planning and management are:

- Human capacity development
 - »»staff performance and motivation
- Desired endpoint:Sufficient,well trained and motivated staff, available to provide safe, quality care.
- management of equipment, supplies and drugs
- assessment and monitoring
- organization of services, including referrals to higher and lower levels
- assuring safe services of high quality
- community involvement

Human capacity development

The training requirements for each category of care provider are based on the skills needed to perform the job. It is recommended that early Infant male circumcision be a primary task of non-physician health-care workers (nurses, midwives and clinical officers). However, this will have to be in line with Kenyan national regulations.

The Ministry of Health and counties will implement an approach to the training of health-care providers in line with existing capacity-building plan, with reference to both in-service and pre-service aspects. A multidisciplinary team approach will be used in training courses. Initially, it is important to adopt an in-service training approach that considers the case-load available for early infant procedures.

Management of equipment, supplies and drugs

The procurement, distribution, storage and utilization of equipment and drugs related to early infant circumcision will comply with the management systems of the national supply chain. Programme managers will make the people in charge of such systems aware of the newer needs of scaling up HIV/AIDS prevention programme. Managers at programme and facility levels will incorporate the required equipment, supplies and drugs for EIMCinto the routine logistics and procurement systems.

Ensuring community involvement

Understanding the community perspective is essential in planning the national early infant male circumcision programme. It is important to understand the family dynamics of decision-making for early infant male circumcision and the preferred timing of the procedure. Once there is agreement on the programme roll-out, counties may opt to make early-infant-friendly circumcision services available at more than one location in the community. Education and demand creation for the circumcision of male infants will be carried out at various service delivery points and referral will be made to facilities where the services are being offered. The services for male circumcision will be made available before demand is generated.

Assessment and monitoring

An assessment of the current state of MNCH services and minor surgical care will be carried out. It will explore how the services are perceived by clients and the community, how they can help to focus efforts where critical changes are needed, and how to assist the program in establishing efficient services that infants and their parents/guardians will use. (Refer to Chapter 12 for monitoring indicators and relevant questions.) As the country has a relatively high baseline infant mortality of 49 out of 1000 babies dying before their first birthday (Source: data.worldbank.org/indicator/SP.DYN.IMRT.IN World Bank), we anticipate that during the implementation of the early infant male circumcision programme, some infant deaths may be inappropriately attributed to the procedure. The programme will therefore monitor mortality rates to accurately assess the impact of male circumcision on overall infant mortality.

Organization of services

The Kenya safe clinical early infant male circumcision programme will target male infants up to the age of 2 months. Many parents return to health facilities for either immunization or family planning counselling and services within 45 days postpartum. The additional 2 weeks after the usually recommended 6-week postpartum visit helps to accommodate mothers who cannot bring their infant within the first week or by the first postpartum visit. Careful clinical and programmatic consideration and skill proficiency are needed in relation to circumcision services after 2 months of life, as the rate of device-related complications increases with age after this time.

In order to determine when and where services will be offered, the following issues will be considered.

- **Integration and linkages:** For the provision of male circumcision essential neonatal care services (See Annex 15) will be carefully considered. Every young infant and/or guardian of young infant coming for male circumcision will have access to all recommended elements of essential neonatal and early infant care, preferably in a single visit.¹²¹ Male circumcision services will also be integrated into routine education and care in antenatal care and into maternity/postnatal care, family planning and immunization care services. The needs of the parents will also be considered and this opportunity will be used to promote good health and provide them with education on HIV prevention.
- **Multiple contacts:** Parent/guardian education and counselling on safe medical early infant male circumcision will be available at every antenatal visit and at postnatal visits.
- **Convenience:** Early infant male circumcision services will preferably be located as close to the above service entry points as possible. In cases where this is not feasible, the parent/infant will be assisted/escorted to the appropriate clean procedure room in the facility so that the service can be provided during the same visit.
- **Remove barriers:** Assessments will be made whether services are early-infant/parent/guardian-friendly. Change processes and procedures that discourage their use (e.g. burdensome or duplicative administrative requirements, cost, long waiting times, perception that local culture is not respected, multiple visits required, not all decision-makers have been informed, perception that the procedure is more risky for babies than adults, lack of transport, cultural barriers such as desire for ritual circumcision later in life, religious beliefs, concerns about infant's pain/ discomfort, and other risks/considerations).
- **Comprehensive approach:** Comprehensive care for the infant will be provided, including: intake, physical assessment, history-taking, education/counselling, appropriate care based on these steps, return visits, identification and referral for other health-care needs.

- **Exclusion criteria:** In order for providers to rule out the presence of any other neonatal conditions, circumcision will not be performed until at least 12 to 24 hours after birth.¹²² This recommendation is based on the projected time needed for providers of neonatal care and treatment to perform a complete assessment of the neonate and ensure that the infant is stable.

Quality assurance

Quality assurance is the assessment or measurement of the quality of care and services and the implementation of any necessary changes to either maintain or improve the quality of care rendered. The quality of male circumcision services can be defined through the development and communication of standards. Kenya will adapt the WHO comprehensive guide to quality assurance for male circumcision programmes.¹²³ The program will strive to meet the ten service standards from these guidelines (Box 1) which include the essential competences for the provision of male circumcision services. All relevant staff members will be familiar with these standards. The national program will support supervision for quality assurance and ensuring that standards are met as per the guidelines. Training will continue to ensure that there is a QA team at every county.

Box 1. WHO-recommended standards for male circumcision services

Standard 1. An effective management system is established to oversee the provision of male circumcision services.

Standard 2*. A minimum package of male circumcision services is provided.

Standard 3. The facility has the necessary medicines, supplies, equipment and environment for providing safe male circumcision services of high quality.

Standard 4. Providers are qualified and competent.

Standard 5. Clients are provided with information, education and counseling for HIV prevention and male circumcision.

Standard 6. Assessments are performed to determine the client's condition.

Standard 7. Male circumcision surgical care is delivered according to evidence-based guidelines.

Standard 8. Infection prevention and control measures are practised.

Standard 9. Continuity of care is provided.

Standard 10. A system for monitoring and evaluation is established.

**The minimum package of services that are not directly relevant for the infant (e.g. management of sexually transmitted infections, condom promotion and risk reduction counselling) should, as far as possible, still be available to offer to parents. To the extent possible, staff should be trained to provide integrated services for parents and infants. Direct linkages should be established with other sites offering these services to allow for easy referral.*

Referrals

Standing referral and feedback arrangements will be put in place to address key needs of the early infant male circumcision service and opportunities, including:

- 
- protocol in place for potential referrals related to conditions identified as contraindications, emergencies and serious complications of male circumcision procedures;
 - encouragement for HIV counseling and testing for couples who present with an infant, and provision of referrals to the service;
 - referral of all HIV-exposed infants to HIV care and support, prophylaxis and, if necessary, treatment services;
 - referral for family planning follow-up, especially for parents/guardians who do not seek routine health services / follow-up in the facility where they delivered;
 - Referral for appropriate education and support relating to infant feeding options.
 - Referrals to immunization services as appropriate

As a general rule, a well established management and referral system to specialist surgeons and paediatricians should be put in place before facilities begin to offer EIMC services.

Annex 1:

Sample checklist for early infant male circumcision equipment

Equipment

▪	Secure work surface (table or infant warmer) of sufficient height for provider.
▪	Assistant or mechanism to restrain/position infant.
▪	Check hand washing/cleaning facilities.
▪	Check light source.

Supplies

▪	Infant padding, blankets and towels.
▪	Clean nappies/diapers and wipes.
▪	Sterile gloves.
▪	Sterile drapes with small opening in the centre (fenestration).
▪	Povidone iodine or other skin-sterilizing preparations.
▪	Sterile 2 x 2 or 4 x 4 gauze pads.
▪	White petroleum jelly or white petrolatum gauze.

Instruments

▪	Instrument trays, wrapped and sterile.
▪	One 7.5-cm to 12.5-inch flexible probe.
▪	Three small mosquito haemostats, two curved and one straight.
▪	Small straight scissors.
▪	Desired male circumcision device (Mogen Clamp).
▪	Scalpel (no. 10 blade or similar).

Anaesthesia administration

▪	1% lidocaine (WITHOUT EPINEPHRINE).
▪	1-ml sterile syringes with small 27-gauge or similar needle.
▪	Alcohol wipes.

Post-circumcision bleeding

▪	Topical epinephrine.
▪	Gel foam or equivalent.
▪	Adson forceps.
▪	4-0 absorbable suture (chromic or catgut) on a needle.
▪	Needle holder.
▪	Petroleum-coated gauze.

Annex 2:

Sample information sheet for early infant male circumcision

Circumcision is the surgical removal of all or part of the foreskin covering the end of the penis. The decision to have an infant male circumcised is very personal and should only be made after careful consideration. The following information is provided to help you make an informed decision. We encourage you to discuss any questions or concerns with your health-care providers.

Benefits of male circumcision

1. Cleanliness – Under certain circumstances, dirt, sand, lint and other irritants can collect under the foreskin and cause inflammation and infection. Male circumcision helps to prevent this type of irritation and makes it easier to clean the head of the penis.
2. Prevention of paraphimosis, an extremely rare condition that occurs when the foreskin becomes retracted or pulled down below the tip of the penis and becomes stuck. The tissue can become swollen and can decrease the blood flow to the tip of the penis, requiring urgent surgery to correct the problem. Circumcision prevents this complication from occurring.
3. Decreased risk of urinary tract infections. Circumcision decreases the risk of urinary tract infections in males, both infants and adults. Uncircumcised infants have a 1% chance of acquiring a urinary tract infection. This type of infection is 10 times less common in circumcised infants, for whom there is only a 0.1% chance of developing a urinary tract infection.
4. Decreased risk of HIV infection. Circumcision has been proved to help prevent female to male transmission of HIV, reducing the risk of transmission by 60–70%.
5. Decreased risk of other sexually transmitted diseases. Circumcision has been proved to help protect against contracting genital herpes and some other sexually transmitted diseases.
6. Prevention of cancer of the penis. Cancer of the penis is extremely rare but occurs much more commonly in men who are uncircumcised than in those who are circumcised.
7. Prevention of cervical cancer in female sexual partners. Cervical cancer is less common in women who have sexual partners who are circumcised. Sex with either uncircumcised men or men circumcised after infancy increases a women's risk of cervical cancer.
8. Avoiding the need for circumcision later in life. Some uncircumcised males will require circumcision later in life for medical reasons.

Risks of male circumcision

1. Lack of informed consent. An infant cannot consent to the procedure. The decision must be made by the family. The procedure is considered permanent and there is a risk that when the child is older he will be unhappy he was circumcised as an infant.
2. Pain. This can be reduced and even eliminated with the use of safe and effective medications. Please discuss the use of pain medication with your health-care team.

3. Surgical risk. Complications during male circumcision are rare, being estimated to occur in 1 of every 500 procedures. These complications, which can be severe, include poor cosmetic outcome, bleeding, infection, injury to the penis and the removal of too much or too little skin.
4. Expense. There may be a cost associated with the procedure.
5. Change in sexual satisfaction. Some people believe that circumcision leads to decreased sexual pleasure later in life. Data recently collected from a large group of adult males who underwent circumcision later in life suggest that there is no change in sexual satisfaction between circumcised and uncircumcised men and their partners. However, some patients may be unhappy that they were circumcised.w

Annex 3:

Overview of counselling skills

All counsellors need certain basic counselling skills in order to talk with parents and guardians in a helpful way. Some of these skills are explained below.

Empathizing

Empathy is the ability to see the world through another person's eyes and understand how that person feels. Counsellors should listen to parents or guardians carefully and show them that they understand without judging. Empathy is not sympathy. It is not feeling sorry for the client but understanding the parent's or guardian's feelings.

Active listening

Active listening involves paying attention to what a guardian or parent says and does, in a way that shows respect, interest and empathy. Active listening is more than just hearing what parents or guardians say. It is paying attention to the content of the message as well as to the feelings and worries that show through movements, tone of voice, facial expressions and posture.

Open questioning

Open questions require more than a one-word, "Yes/No" type of answer. They usually begin with words such as "How", "What" or "Why". Open questions encourage parents or guardians to express their feelings and share information about their situation.

Probing

Probing involves using questions to help parents or guardians express themselves more clearly. It is necessary when the counsellor needs more information about the parent's or guardian's feelings or situation. Asking a probing question is a good way to follow up on a question that has been answered by "Yes" or "No".

Focusing

Focusing allows the patient to share concerns and worries more easily. Parents or guardians are often overwhelmed by emotional or personal problems related to their particular child's needs or health problems. They may want to address all the issues at once. If parents or guardians start to talk about problems or situations that will be discussed later in the session, the counsellor may want to bring the topic of discussion back to the current issue.

Affirming

Affirming is congratulating or complimenting parents or guardians on the positive actions that they have taken. It is important to encourage success. Complimenting parents or guardians helps them to feel respected and valued and encourages them to try to make other changes to enhance good health choices for their children. It may also make them more willing to share information about other actions they have taken.

Clarifying

Counsellors clarify in order to make sure that they understand parents' or guardians' statements or questions. Clarifying also helps parents or guardians to understand their own situation or feelings better and to identify uncertainty or conflict between their thoughts and behaviour.

Pointing out a conflict may help a parent or guardian to identify which of two issues is more important to them. This is better than the counsellor telling the parent or guardian to do something that he or she is not ready to accept. Clarifying also helps parents or guardians to make their own choices and draw their own conclusions. Saying "Help me to understand this" is a good way to begin this type of discussion

Correcting false information

It is important to provide correct information to parents or guardians and to correct any myths and false information. There are many incorrect rumours about male circumcision. These should be corrected. However, this needs to be done in a sensitive way, without making the parent or guardian feel belittled or defensive. Counsellors should acknowledge false information and then correct it quickly. It is not necessary to give detailed explanations.

Summarizing

Counsellors summarize in order to present the main points of the conversation to parents or guardians. Summarizing can be useful when moving to another topic or ending the session, and to make sure that counsellor and parent or guardian have understood each other correctly.

Summarizing also helps parents or guardians see the whole picture and understand the situation better.

Confidentiality

Confidentiality is an important characteristic of all health services. Counsellors should keep all information private and allow parents or guardians to decide when and with whom to discuss the infant male circumcision issues and other health problems. Parents or guardians will feel more comfortable about sharing personal information with counsellors if they know that it will remain private. An atmosphere of trust will encourage parents or guardians to discuss other health needs of their children.

Annex 4:

Sample client record form for early infant male circumcision

Name of Patient (Block Capitals)	
Date of Procedure	Date of Birth

General information

Name of parent/guardian:	
Address Line 1:	
Address Line 2:	
Card ID number:	
Place of delivery:	<input type="checkbox"/> Same facility <input type="checkbox"/> Different facility <input type="checkbox"/> Home <input type="checkbox"/> Other _____ (specify)
Ethnicity:	
Religion of parent/guardian:	
Primary reason for MC:	
HIV test/exposure status:	HIV test performed for mother <input type="checkbox"/> Yes <input type="checkbox"/> No HIV test result of mother <input type="checkbox"/> n/a <input type="checkbox"/> -ve <input type="checkbox"/> +ve HIV test performed for father <input type="checkbox"/> Yes <input type="checkbox"/> No HIV test result for father <input type="checkbox"/> n/a <input type="checkbox"/> -ve <input type="checkbox"/> +ve

Medical history

Bleeding disorder:	<input type="checkbox"/> No	<input type="checkbox"/> Yes	Convulsions:	<input type="checkbox"/> No	<input type="checkbox"/> Yes
Premature delivery:	<input type="checkbox"/> No	<input type="checkbox"/> Yes	Hospitalization:	<input type="checkbox"/> No	<input type="checkbox"/> Yes
Fever:	<input type="checkbox"/> No	<input type="checkbox"/> Yes	Swelling of scrotum:	<input type="checkbox"/> No	<input type="checkbox"/> Yes
Other (specify):	_____				

Physical examination

Birth weight <2.5 kg:	<input type="checkbox"/> No	<input type="checkbox"/> Yes	Normal cardiac examination:	<input type="checkbox"/> Yes	<input type="checkbox"/> No
Growth <5th centile:	<input type="checkbox"/> No	<input type="checkbox"/> Yes	Normal pulmonary examination:	<input type="checkbox"/> Yes	<input type="checkbox"/> No
Specify abnormal findings: _____					
Penile torsion	<input type="checkbox"/> No	<input type="checkbox"/> Yes	Median raphe not midline	<input type="checkbox"/> No	<input type="checkbox"/> Yes
Hypospadias	<input type="checkbox"/> No	<input type="checkbox"/> Yes	Abnormal urethra	<input type="checkbox"/> No	<input type="checkbox"/> Yes
Buried penis	<input type="checkbox"/> No	<input type="checkbox"/> Yes	Penile scrotal web	<input type="checkbox"/> No	<input type="checkbox"/> Yes
Hydrocele	<input type="checkbox"/> No	<input type="checkbox"/> Yes	Dorsal hood	<input type="checkbox"/> No	<input type="checkbox"/> Yes
Buried penis	<input type="checkbox"/> No	<input type="checkbox"/> Yes	Penile scrotal web	<input type="checkbox"/> No	<input type="checkbox"/> Yes
Abnormal scrotal ruggae	<input type="checkbox"/> No	<input type="checkbox"/> Yes	Abnormal ventral foreskin	<input type="checkbox"/> No	<input type="checkbox"/> Yes
Abnormal findings: _____					

Suitable for male circumcision

Is infant suitable for male circumcision at this clinic?	<input type="checkbox"/> Yes	<input type="checkbox"/> No
Is infant in good general health?	<input type="checkbox"/> Yes	<input type="checkbox"/> No
Have infant's parents/guardians given informed consent?	<input type="checkbox"/> Yes	<input type="checkbox"/> No

If there is any question about suitability, male circumcision should be delayed

Annex 5:

Reported inducers of methaemoglobinaemia

The following exposures should be considered when using EMLA cream to reduce the risk of methaemoglobinaemia.

Reported inducers of methaemoglobinaemia	
Agent	Sources/drugs
Inorganic nitrates/nitrites	Contaminated well water Meat preservatives Vegetables, i.e. carrot juice, spinach Silver nitrate burn therapy Industrial salts Contaminants of nitrous oxide canisters for anaesthesia
Butyl/isobutyl nitrite Amyl nitrite Nitroglycerin	Room deodorizer propellants Inhalant in cyanide antidote kit Pharmaceuticals for treatment of angina
Aniline/aminophenols Nitrobenzene Sulfonamides Phenazopyridine Antimalarials Sulfones p-aminosalicylic acid Naphthalene Copper sulfate Resorcinol Chlorates Combustion products Local anaesthetics	Laundry ink Industrial solvents; gun-cleaning products Antibacterial drugs Pyridium Chloroquine; primaquine Dapsone Bactericide (tuberculostatic) Mothballs Fungicides for plants, seed treatments Antiseborrheic, antipruritic, antiseptic Matches, explosives, pyrotechnics Fires Benzocaine; lidocaine; propitocaine; prilocaine

Annex 6:

Sample checklist for early infant male circumcision procedure

Procedure preparation, education and screening

<input type="checkbox"/>	Ensure availability of appropriate instruments and supplies	Review Male circumcision checklist equipment
<input type="checkbox"/>	Provide information to parents / legal guardians as to risks and benefits of MC	Review Male circumcision information handout
<input type="checkbox"/>	Determine if the parents / legal guardians want their child to undergo MC	Review Male circumcision consent form and sign
<input type="checkbox"/>	Thoroughly wash/clean hands	
<input type="checkbox"/>	Screen patient to determine eligibility for early infant male circumcision (history and physical)	Review Male circumcision client record form
<input type="checkbox"/>	Ensure identity of infant	Safe surgery 'time out' (safety check)

Patient preparation

<input type="checkbox"/>	Determine device and appropriate size. Ensure device has been properly sterilized.
<input type="checkbox"/>	Determine and prepare most appropriate form of anaesthesia.
<input type="checkbox"/>	Position patient.
<input type="checkbox"/>	Prepare the surgical area with povidone iodine or equivalent antiseptic agent.
<input type="checkbox"/>	Put on sterile gloves and proceed using sterile technique.
<input type="checkbox"/>	Inspect/assemble device, ensure size and that the Mogen Clamp has matching device parts.
<input type="checkbox"/>	Drape the surgical area.

Prepuce preparation

<input type="checkbox"/>	Mark the location of the incision at the corona. The penis should be clean and dry.
<input type="checkbox"/>	Administer anaesthesia. Wait for effectiveness.
<input type="checkbox"/>	Grasp foreskin with two curved haemostats at 3:00 and 9:00.
<input type="checkbox"/>	Remove adhesions using blunt, flexible probe.
<input type="checkbox"/>	Dilate foreskin opening or, if necessary, create dorsal slit (optional for Mogen clamp).
<input type="checkbox"/>	Retract foreskin (optional for all devices).

Mogen

Gomco

Plastibell

<input type="checkbox"/>	Apply dorsal haemostat.	<input type="checkbox"/>	Insert bell/shield.	<input type="checkbox"/>	Loosely apply ligature.
<input type="checkbox"/>	Approximate foreskin.	<input type="checkbox"/>	Apply Gomco clamp.	<input type="checkbox"/>	Insert bell/shield.
<input type="checkbox"/>	Apply Mogen clamp.	<input type="checkbox"/>	Align foreskin.	<input type="checkbox"/>	Align foreskin.
<input type="checkbox"/>	Align foreskin.	<input type="checkbox"/>	Activate clamp.	<input type="checkbox"/>	Tightly apply ligature.
<input type="checkbox"/>	Activate clamp.	<input type="checkbox"/>	Incise foreskin.	<input type="checkbox"/>	Excise extra foreskin.
<input type="checkbox"/>	Incise foreskin.	<input type="checkbox"/>	5-minute clamp time.		
<input type="checkbox"/>	5-minute clamp time.				

Immediately postoperative

<input type="checkbox"/>	Inspect for any injury to surrounding structures.
<input type="checkbox"/>	Remove any residual adhesions, optional (Gomco/Mogen).
<input type="checkbox"/>	Reduce foreskin below corona (Gomco/Mogen).
<input type="checkbox"/>	Apply petroleum-coated ribbon dressing (Gomco/Mogen).
<input type="checkbox"/>	Instructions should be posted in procedure room.
<input type="checkbox"/>	Monitor bleeding and urine output – all devices. Bleeding protocol should be posted in procedure room.

Post-procedure documentation and education

<input type="checkbox"/>	Complete procedure notes.
<input type="checkbox"/>	Review post-circumcision care instruction.
<input type="checkbox"/>	Review post-circumcision precautions.
<input type="checkbox"/>	Review emergency contact information.

Postoperative processing

<input type="checkbox"/>	Check sterilization and reprocessing equipment.
<input type="checkbox"/>	Check sharps container (way to handle / dispose of contaminated sharps).
<input type="checkbox"/>	Check waste container (way to handle / dispose of contaminated supplies).

Annex 8:

Sample documentation form for early infant male circumcision procedure

Annex 7: Sample consent form for early infant male circumcision

Name of Patient (Block Capitals)	
Date of Procedure	Date of Birth
Name of Patient (Block Capitals)	

Infant

<input type="checkbox"/>	Term	Date of Procedure	
<input type="checkbox"/>	Informed consent has been obtained and documented		
<input type="checkbox"/>	No family history of bleeding was reported		
<input type="checkbox"/>	Patient examined and no urogenital/anatomical abnormalities were noted		
<input type="checkbox"/>	Patient identity checked and relationship to patient/child:		
<input type="checkbox"/>	Safety pause		
<input type="checkbox"/>	Patient positioned and prepared and procedure completed using sterile technique		

I am asking you to do a circumcision operation (removal of the foreskin) on _____
I give you permission to do this operation.

Anaesthesia

<input type="checkbox"/>	Lidocaine 1% without epinephrine	<input type="checkbox"/> 1 ml sc	<input type="checkbox"/> _____ (dose and route)
<input type="checkbox"/>	Dorsal penile nerve block	Signed ... <input type="checkbox"/> Penile ring block	
<input type="checkbox"/>	Oral sucrose administration	(Parent or legal guardian)	<input type="checkbox"/> EMLA cream

Procedure

Name of counsellor/surgeon: _____ (BLOCK CAPITALS)

I am the counsellor/surgeon who has given information to the parent or guardian above-mentioned boy.

Device used: Gomco Mogen Plastibell _____ (device size)

Haemostasis was obtained using: Direct pressure Liquid epinephrine Surgical

Suture _____ (type and number)

Patient tolerated procedure well

No complications were observed and good cosmetic outcome was obtained

Blood loss was minimal

Vaseline-impregnated sterile gauze dressing applied

Notes:

- what circumcision is;
- the benefits of circumcision;
- how circumcision is done;
- the risks of circumcision;
- what to do before circumcision;
- what to do after circumcision;
- what to do if there are any complications or problems after circumcision;
- an emergency contact number and where to go in an emergency.

Postoperative care

<input type="checkbox"/>	Patient returned to parent/guardian having given the client an opportunity to ask me questions about all the above
<input type="checkbox"/>	Postoperative care instructions reviewed with parent/guardian some questions to make sure that he or she understands the information I have given.
<input type="checkbox"/>	Postoperative precautions reviewed with parent/guardian
<input type="checkbox"/>	Emergency contact information/procedures reviewed with parent/guardian

To the best of my belief the client is capable of giving consent and has enough information to make a proper decision about whether to proceed with the operation of

Surgeon's signature: _____

Surgeon's name: _____

Signed _____

(Clinic counsellor or surgeon)

Annex 9:

Overview of suturing and wound closure

Most early infant male circumcisions will not require any type of suturing or wound closure. Once the incision is made and the clamp is released, the wound is managed conservatively without primary closure. In very rare cases, however, the need may arise to close the wound and/or use a suture to ligate a vessel for haemostasis.

To close a circumcision wound the edges of the foreskin are sutured together with 4/0 vicryl or chromic catgut sutures and a round-bodied needle. Cutting needles should not be used. The suture size is a compromise between ensuring adequate tensile strength and keeping the amount of foreign material to a minimum.

Approximate the skin edges using simple sutures, as shown below. More complex mattress sutures are not necessary.

Figure. A.1. Technique for applying a simple suture

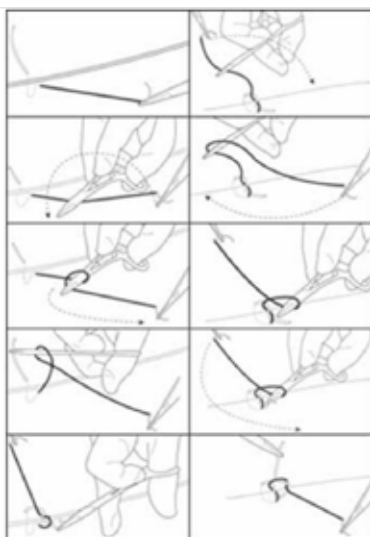

Before approximating the skin, ensure that the frenulum is aligned at the 6 o'clock position. Take great care in this area, because the urethra is near the ventral surface and can easily be injured by too deep a stitch bite. Place all sutures approximately 1 mm from the skin edge. Place the first two sutures at the 12 o'clock and 6 o'clock positions, leaving them long and temporarily held with forceps (Figure A.2). This keeps the penis stable while the remaining sutures are completed. In infants, only two further stitches may be needed on each side.

Figure A.2. Suturing the circumcision wound

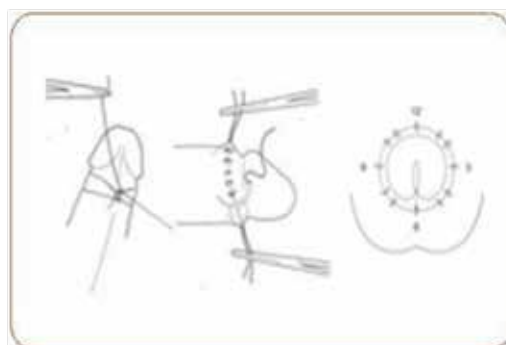

Annex 10:

Sample postoperative information sheet for early infant male circumcision

1. My child has gauze wrapped around his penis. When should this come off?

If it does not fall off on its own the gauze should be removed in 48 hours. To remove the gauze it should be soaked with warm water and then carefully unwrapped. If bleeding occurs follow the instructions below.

2. What do I need to do to take care of the area that is healing?

No special care is needed except placing petroleum jelly (Vaseline/A&D ointment) on the penis. Apply a lot, this will protect the area that is healing and prevent the penis from sticking to the nappy/diaper. Apply this with every nappy change for the first 3–5 days following the circumcision or longer if the penis still looks as if it is healing and may stick to the nappy. If an absorbable nappy is not available the infant may be left bare and the healing area should be kept as clean and dry as possible.

3. What if there is bleeding?

A small amount of blood on the gauze or nappy is almost always present and is normal. If you see blood soaking the nappy or making a spot greater in size than your two thumbs, you should seek medical attention. If an area begins to bleed when you are changing the nappy, hold direct pressure with gauze on the site for 5 minutes. This should stop the bleeding but if it does not do so you should continue holding pressure on the area and seek medical attention.

4. There is something on the penis that looks like pus. Should I be worried?

During the healing process a shiny white or yellowish film may cover part of the penis. This coating is part of the healing process and cannot be easily removed with a moist wipe. This is normal. However, if you see a yellowish discharge that you can wipe away, has a foul odour and is causing increasing redness and swelling, seek medical attention. A general rule is that the healing area will have some swelling and redness but should start to look better 48 hours after the procedure. Subsequently, the healing area should continue to look better every day. If your infant ever develops a fever, stops having wet nappies/diapers, stops eating or becomes inconsolable, or if the area appears to be infected or not healing, seek medical attention.

5. How long does it take to heal?

It may take several days to a week for a circumcision to heal completely. During this time you should be gentle around the area and try to keep the area clean until it has completely healed. Most circumcisions will be fully healed by 2 weeks.

6. The foreskin looks as if it is coming back over the head of the penis. Is that OK?

Most babies develop a small area of fat at the base of the penis during the first year of life. This is normal and can cause some of the skin of the penis to get pushed up and cover part of the head of the penis. The penis may look buried or uncircumcised. It is important to gently retract the skin to the base of the head of the penis several times a day to prevent the foreskin from reattaching to the head of the penis. As your infant grows, this should get better with more of the tip of the penis showing all the time. Not all babies have this fat pad and so the look of the circumcision is not always the same in different children, even when the correct amount of skin is removed during the circumcision.

7. If you have any questions about the circumcision wound or the care of your infant, please call your local health-care provider.

Annex 11:

Sample wound-dressing poster for early infant male circumcision



Ensure foreskin is reduced below the glans



Open supplied gauze pack

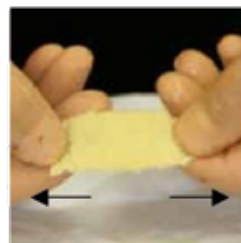

Stretch gauze until it is straight



Fold gauze in half lengthwise



Flatten with your finger



Apply liberal amount of petrolatum (petroleum jelly ointment)



Wrap gauze around the shaft of the penis



Ensure the glans can be visualized to observe for bleeding and allow for the passage of urine



Pull gauze until the dressing is snugly applied to the wound



Wrap the remainder of the dressing neatly around the penis

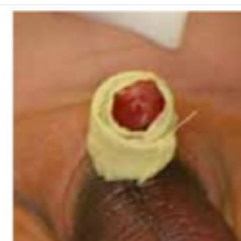

Apply liberal amount of petrolatum to the tip of the penis and apply diaper



If dressing is tightly applied monitor urine output closely

Alternative to xeroform gauze



Unfold 2 x 2 or 4 x 4 gauze pad



Fold gauze pad into 1-inch strip and apply a liberal amount of petrolatum



Fold dressing in half lengthwise, impregnating the gauze with petrolatum



Apply liberal amount of petrolatum and apply as above

Note: If bleeding occurs, direct pressure should be applied over the dressing. The dressing can be left on for 24 to 48 hours and should be removed only after being thoroughly soaked with warm water during bathing. While the dressing is on, bleeding and urine output should be closely monitored

Annex 12:

Sample postoperative bleeding protocol for early infant male circumcision

Prevention

1. Enquire about a family history of bleeding disorders.
2. Use a flexible probe to remove adhesions in place of a haemostat to avoid injuring the frenular artery.
3. Move the flexible probe up and down, ensuring that the adhesions have been adequately removed, before application of the clamp and incising the foreskin.
4. If subcoronal adhesions exist following the procedure, gently reduce these by using gauze to separate the foreskin from the glans. Try to avoid disrupting the wound.
5. Use a 5-minute clamp time (by the clock) as originally described by Dr Yellen, the inventor of the Gomco clamp.
6. Use a dressing that is well applied to the wound and not just placed on top of the penis.

How to manage bleeding with clamping devices

1. Don't panic. During many traditional circumcisions, the foreskin is never crushed before making the incision, yet, even under these extreme circumstances, severe complications from bleeding are rare.
2. Closely inspect the penis to ensure that there has been no injury to the glans or other surrounding structures.
3. Using gauze, apply temporary direct pressure to the wound while carefully applying a firm circumcision dressing.
4. If bleeding continues through or around the dressing, leave the dressing in place and apply direct pressure over it for 5 minutes by the clock.
5. If bleeding continues the dressing should be removed and the wound re-inspected. Frenular artery bleeding comes from a small area on the ventral side. If the bleeding is diffuse and rapid, consider the possibility of a bleeding disorder and seek immediate medical and surgical consultation.
6. If the bleeding appears to be minor, reapply a compression dressing and apply direct pressure over the dressing for 10 minutes by the clock. If bleeding continues despite these conservative measures, medical and surgical intervention should be considered while continuing to hold direct pressure.

How to manage bleeding with the Plastibell device

1. Ensure that the ligature is tied tightly. If necessary, retie the tourniquet with a new ligature.
2. During placement of the Plastibell, the frenular artery can be injured, resulting in bleeding. This bleeding will not originate from the skin edge, but from beneath the plastic bell. Cotton-tip applicators can be used to apply pressure in the area of the bleeding through the hole of the Plastibell device.
3. If bleeding cannot be controlled by these means the ligature should be cut and the Plastibell removed. The steps outlined above for clamping devices can then be followed.

Annex 14:

Sample monthly facility summary form for early infant male circumcision

Facility name: _____

Month of report: _____

Name of person completing report: _____

Contact of person completing report: _____

Indicator		Total
Number of male babies circumcised for age group	Less than 7 days	
	7–28 days of age	
	1–2 months	
	2 months and older	
	<i>Total</i>	
Number of parents/guardians counselled and tested for HIV		
Number of HIV-exposed babies circumcised		
Number of babies circumcised who experienced one or more adverse events		
Number of circumcised male babies brought back at least once for postoperative follow-up care (routine or emergency) within 2 weeks of the procedure		
Referred from:		
Self-referral (parents/guardians)		
Antenatal care		
Family planning		
Maternity and labour/delivery		
Paediatric ward and outpatient department		
Other		
<i>Total referred from all settings</i>		
Referred to:		
Paediatric HIV care and treatment centre		
Paediatric outpatient department and/or ward		
Other clinical surgical services		

Annex 15:

Essential neonatal and infant care interventions at home/community level

Promotion and support for:

- Exclusive breastfeeding
- Thermal protection
- Infection prevention: general hygiene, hand-washing, cord care and safe disposal of baby's faeces
- Care of a small baby without breathing and feeding problems: frequent breastfeeding, skin-to-skin contact
- Prevention of indoor air pollution
- Neonate stimulation and play
- Recognition of problems, illness and timely care-seeking
- Support for routine care and follow-up visits
- Birth registration

Situational:

- Promotion and provision of insecticide-treated bednets
- Adherence to antiretrovirals for PMTCT

Interventions at first-level health facilities

All of the above plus:

- Rooming in
- Promotion, protection and support for exclusive breastfeeding
- Eye infection prophylaxis
- Immunization
- Presumptive treatment of congenital syphilis
- Monitoring and assessment of well-being and response to maternal concerns
- Additional follow-up for at-risk babies
- Treatment of local infections (skin, cord, eye, mouth)
- Identification, initial management and referral of a neonate with any sign of severe illness, injury or malformation
- Care of preterm / low-birth-weight infants without breathing problems: support for breast(-milk)feeding, Kangaroo Mother Care
- Recording and reporting

Situational:

- All of the above plus:
- Antiretroviral regimens for PMTCT including antiretroviral therapy
- Support for safer infant feeding options

Interventions at referral facilities

All of the above plus:

- Management of a neonate with severe problems: general care of a sick neonate and specific care for:
 - preterm babies with breathing problem or unable to feed orally (includes provision of Kangaroo Mother Care)
 - severe infection
 - severe birth asphyxia
 - other: severe jaundice, malformations

Annex 16:

Sample Infant Circumcision Lignocaine and Paracetamol dosing guide

i) Paracetamol Dosing

Dose range is 10-15 mg/kg body weight.

Provide sterile 3ml syringe to the client

Body weight in kg	Dose in ml
2.5	1
2.6 - 3.4	1.5
3.5 - 4.4	2
4.5 - 5.4	2.5
5.5 - 6.4	3

ii) Lignocaine Dosing (if only 2% lignocaine available)

Maximum dose 0.15mg/kg body weight

Use 1 ml insulin syringe

Weight (kg)	Max dose 2% Lignocaine - ml	Water for Injection - ml	Total Volume in Syringe - ml
2.5-2.9	0.35	0.65	1.0
3.0-3.4	0.45	0.55	1.0
3.5-3.9	0.5	0.5	1.0
4.0 - 4.4	0.6	0.4	1.0
4.5 - 4.9	0.65	0.35	1.0
5.0 – 5.4	0.75	0.25	1.0
5.5 – 5.9	0.85	0.15	1.0
6.0 – 6.4	0.9	0.1	1.0

Annex 17:

Weight for Age Reference Guide

**Standards for Early Infant Male Circumcision
Weight-for-Age of Infants from Birth to 60 Days of Age
2 Z-scores Below the Mean Weight-for-Age
WHO Child Growth Standards***

Age in Days	Weight in kg
Birth	2.5
7 Days	2.6
14 Days	2.8
21 Days	3.1
28 Days	3.3
35 Days	3.5
42 Days	3.8
49 Days	4.0
56 Days	4.2

***Infants weighing less than indicated at a given age should be excluded from circumcision. These cutoffs should exclude approximately 2% of infant boys from being eligible for circumcision in a healthy population**

Annex 18:

Standard Precautions for Injection Safety and Instrument Processing

Tips for the safe use of hypodermic needles and syringes:

- disposable needles and syringes must be used only once;
- do not disassemble the needle and syringe after use;
- do not bend or break needles before disposal;
- dispose of needles and syringes together in a puncture-resistant container.

In general, it is safer to dispose of a needle and syringe directly into a sharps container without recapping. If a needle must be recapped, use the one-handed recapping method as follows.



- Place the needle cap on a firm flat surface.
- Holding the syringe with one hand, use the needle to scoop up the cap.
- With the cap over the needle tip, turn the syringe upright (vertical) so that the needle is pointing towards the ceiling.
- With the forefinger and thumb of your other hand, grasp the cap just above its open end and push it firmly down on to the hub (the place where the needle joins the syringe).

Sharps containers

Clearly labeled, puncture-proof and tamper-proof sharps safety boxes or containers are a key component in efforts to keep injuries from disposable sharps to a minimum.

- Place sharps containers as close to the point of use as possible and practical (ideally within arm's reach), but away from busy areas. Avoid placing containers near light switches, overhead fans or thermostat controls, where people might accidentally put their hands into them.
- Attach containers to walls or other surfaces, if possible, at a convenient height, so that staff can use and replace them easily.
- Mark the containers clearly so that people will not mistakenly use them as rubbish bins.
- Mark the fill line (at the three-quarters-full level). Do not shake the container to settle its contents to make room for more sharps. Never fill the containers more than three-quarters.
- Never attempt to empty a sharps container.

Processing of instruments, environmental cleaning and management of spills

Soiled instruments and other reusable items can transmit infection if they are not properly reprocessed. Effective and safe reprocessing includes decontamination of instruments and equipment immediately after use, cleaning to remove all organic matter and chemicals, and high-level disinfection or sterilization of instruments used in normally sterile critical sites, i.e. within the body, in sterile tissue, cavities or the bloodstream. Before sterilization, all equipment must be decontaminated and then cleaned to remove debris. Sterilization is intended to kill living organisms.

Disinfectant solutions are used to inactivate any infectious agents that may be present in blood or other body fluids. They must always be available for cleaning working surfaces, equipment that cannot be autoclaved and non-disposable items, and for dealing with any spillages involving pathological specimens or other known infectious material.

For decontamination, used instruments should routinely be soaked in a chemical solution (0.5% chlorine) for 10 minutes before cleaning. Decontamination decreases the viral and bacterial burden of an instrument but does not clean debris from the instrument or sterilize it. The purpose of decontamination is to reduce the risk to those who have to handle the instruments during further cleaning. Decontamination is not a sterilizing process and must not be used as a substitute for sterilization.

There are many disinfectant solutions and their effectiveness varies. In most countries the most widely available disinfectant is sodium hypochlorite solution (commonly known as bleach or chlorine), which is a particularly effective antiviral agent.

For cleaning, all used instruments and equipment must be treated with detergent and water before being subjected to high-level disinfection or sterilized. Otherwise, organic matter may prevent adequate contact with the disinfectant or sterilizing agent. Organic matter may also bind and inactivate chemical disinfectants.

Instructions for manual cleaning

- Wear thick household or utility gloves.
- Wear protective eyewear, mask and plastic apron, if available, to prevent contaminated fluids from splashing into your eyes or on to your body.
- Use liquid soap, if available. Do not use abrasive cleaners or steel wool, especially on metal (they cause scratches and increase the risk of rusting).
- Using a soft brush, scrub instruments under the surface of the water to prevent splashing, paying particular attention to any teeth, joints or screws.
- Rinse the instruments with clean water.
- Dry the instruments with a towel or allow them to air-dry.

High-level disinfection

High-level disinfection destroys all microorganisms except some bacterial endospores. It is usually used for heat sensitive instruments and equipment that is used in critical sites but cannot be sterilized. High-level disinfection is the only acceptable alternative to sterilization for heat-sensitive surgical instruments. There is no single ideal disinfectant. Different grades of disinfectant are used for different purposes. However, glutaral (glutaraldehyde) is generally the most appropriate chemical for high-level disinfection. It must be used under very strictly controlled conditions, in a safe work environment, and the manufacturer's handling instructions must be strictly followed.

In situations where sterilization is not possible for equipment used for circumcision, high-level disinfection is the next best acceptable method of instrument processing.

Sterilization

Sterilization is the destruction of all microorganisms, including bacterial endospores. Sterilization can be achieved by either physical or chemical methods. It is necessary for medical devices that will be used in sterile body sites and can be achieved using:

- high-pressure steam (autoclave) or dry heat (oven);
- chemicals, such as ethylene oxide or formaldehyde (Formalin), or glutaraldehyde if left for 10 hours;120
- Radiation.

Sterilization of all surgical instruments and supplies is crucial in preventing HIV transmission. All viruses, including HIV, are inactivated by high-pressure steam sterilization (autoclaving) for 20 minutes at 121–132 °C, or for 30 minutes if the instruments are in wrapped packs. Items that have been sterilized must be properly stored in order to ensure that they do not become re-contaminated.

- The storage area should be clean, dry and free of dust and lint.
- The temperature should be kept at approximately 24 °C and the relative humidity at less than 70%, if possible.
- Sterile packs and containers should be stored 20–25 cm off the floor, 45–50 cm from the ceiling and 15–20 cm from an outside wall.
- Do not use cardboard boxes for storage of sterile items, as they shed dust and debris and may harbour insects.

Mark the date of sterilization on the package and use the oldest packages first (i.e. first in, first out). Dates serve as an indicator of when packs should be used, but they do not guarantee the sterility of the packs. It is therefore necessary to examine the general condition of packs.

Safe disposal of infectious waste materials

Waste management

All facilities should conduct a Health Care Waste Management assessment and develop a plan. This plan should easily be accessible to the health care workers and support staff

The purpose of waste management is to:

- Protect people who handle waste items from accidental injury;
- Prevent the spread of infection to health-care workers and the local community.

Tips for safe handling and disposal of infectious waste

- Place waste in plastic or galvanized metal containers with tightly fitting colour-coded covers that differentiate infectious from noninfectious waste.
- Place all disposable sharps in designated puncture-resistant containers.
- Place waste containers close to where the waste is generated in a position convenient for users.
- Ensure that equipment used to hold and transport waste is not used for any other purpose.
- Regularly clean all waste containers with a disinfectant (0.5% chlorine solution), then wash with water and soap, rinse with water only, and allow air-drying.
- When possible, use separate containers for waste that will be treated or that will be disposed of in a particular manner. In this way, workers will not have to handle and separate waste by hand.

Disposing of sharp items

Disposable sharp items, such as hypodermic needles, require special handling. They are the items most likely to injure the health-care workers who handle them. If these items are disposed of in a municipal landfill they become a danger to people in the community.

Burning waste containers

Burning destroys waste, kills any microorganisms, and is the best method of disposing of contaminated waste. It reduces the bulk volume of waste and also ensures that items cannot be scavenged and reused.

Encapsulating waste containers

Encapsulation is the easiest way to safely dispose of sharps containers. When a container is three-quarters full, pour cement (mortar), plastic foam, clay or other similar material into it until it is completely full. After the material has hardened, seal the container and dispose of it in a landfill or bury it.

Burying waste

In health-care facilities with limited resources the burial of waste (such as excised foreskins) near the facility may be the only practical option for waste disposal. To limit health risks and environmental pollution, the following basic rules should be followed.

- Restrict access to the disposal site. Build a fence around the site to keep animals and children away.
- Line the burial site with a material of low permeability (e.g. clay), if available.
- Select a site at least 50 metres away from any water source to prevent contamination of the water table.
- Ensure that the site has proper drainage, is located downhill from any wells, is free of standing water and is not in an area that floods.

Post-exposure prophylaxis (refer to the PEP job aid/SOP)

Health-care workers may be accidentally exposed to blood and other body fluids that are potentially infected with HIV, hepatitis virus or other blood borne pathogens. Occupational exposure may occur through direct contact of non-intact skin with potentially infected blood or body fluids, from splashes into the eyes or mouth, or through injury with a used needle or sharp instrument. PEP can help to prevent the transmission of pathogens after such an exposure.

Managing occupational exposure to hepatitis B, hepatitis C and HIV

The immediate response to exposure to blood or other fluids that are potentially infected with hepatitis B virus (HBV), hepatitis C virus (HCV) or HIV are summarized here (more details should be available in routine standard protocols in the health facility).

Step 1. Provide immediate first-aid care to the exposure site.

- If a splash or a spill occurs on the skin, wash the area immediately with soap and water. Do not use caustic agents, alcohol or bleach, because they will irritate the skin and may increase the risk of infection. Do not apply a dressing.
- If a splash or a spill occurs in the eyes, the nose, the mouth or on any mucous membrane, rinse the area with clean water for at least 10 minutes.
- If an injury has been caused by a potentially contaminated sharp, wash the area with soapy water and allow the wound to bleed freely (do not squeeze) for a while. Then give routine first aid.

Step 2. Evaluate the risk by determining the type of fluid (blood, visibly bloody fluid, or other potentially infectious fluid), the severity and type of exposure (percutaneous or needle-stick, mucous membranes, intact

or non-intact skin) and the source of infection.

Step 3. If the source person is identified it is important to obtain information on her or his hepatitis and HIV sero-status, and, if positive, to conduct an evaluation of the clinical status and treatment history.

- Assess the risk of infection, using available information.
- The source person may be tested only with her or his informed consent.
- Do not test discarded needles or syringes for virus contamination.
- After the result, refer the health-care worker to receive PEP if available in the same facility (according to the Kenya National guidelines). The client should be linked to care and treatment services if this is the first time.

References

1. Weiss H, Larke N, Halperin D, Schenker I. Neonatal and child male circumcision: a global review. *UNAIDS Technical Bulletin*. April 2010.
2. Auvert B, Taljaard D, Lagarde E, et al. Randomized, controlled intervention trial of male circumcision for reduction of HIV infection risk: the ANRS 1265 Trial. *PLoS Med* 2005;2:e298. .
3. Bailey RC, Moses S, Parker CB, et al. Male circumcision for HIV prevention in young men in Kisumu, Kenya: a randomised controlled trial. *Lancet* 2007;369:643.
4. Gray RH, Kigozi G, Serwadda D, et al. Male circumcision for HIV prevention in men in Rakai, Uganda: a randomised trial. *Lancet* 2007;369:657.
5. Lerman SE, Liao JC. Neonatal circumcision. *Pediatric Clinics of North America* 2001;48(6).
6. Malone P, Steinbrecher H. Medical aspects of male circumcision. *BMJ* 2007; 335:1206-90.
7. Male circumcision: global trends and determinants of prevalence, safety and acceptability. WHO and UNAIDS, 2007.
8. Auvert B, Taljaard D, Lagarde E, et al. Randomized, controlled intervention trial of male circumcision for reduction of HIV infection risk: the ANRS 1265 Trial. *PLoS Med* 2005;2:e298.
9. Bailey RC, Moses S, Parker CB, et al. Male circumcision for HIV prevention in young men in Kisumu, Kenya: a randomised controlled trial. *Lancet* 2007;369:643.
10. Gray RH, Kigozi G, Serwadda D, et al. Male circumcision for HIV prevention in men in Rakai, Uganda: a randomised trial. *Lancet* 2007;369:657.
11. Wiswell TE et al. . Effect of circumcision status on periurethral bacterial flora during the first year of for life. *J Pediatr* 1988;113(3):442-6.early
12. Kariher DH, Smith TW. Immediate circumcision of the newborn. *Obstetrics and Gynecology* 1995;7(1):50-53.infant
13. American Association of Family Physicians. Position paper on neonatal circumcision. 2007.
14. Greenberg MJ. Gomco circumcision. *American Family Physician* 1999;59(10).
15. Peleg D, Steiner A. The Gomco circumcision: Common problems and solutions. *American Family Physician* 1998;58:891-8.
16. Auvert B, Taljaard D, Lagarde E, et al. Randomized, controlled intervention trial of male circumcision for reduction of HIV infection risk: the ANRS 1265 Trial. *PLoS Med* 2005;2:e298.
17. Bailey RC, Moses S, Parker CB, et al. Male circumcision for HIV prevention in young men in Kisumu, Kenya: a randomized controlled trial. *Lancet* 2007;369:643.
18. Gray RH, Kigozi G, Serwadda D, et al. Male circumcision for HIV prevention in men in Rakai, under Uganda: a randomized trial. *Lancet* 2007;369:657.
19. Shaikh N, Morone NE, Bost JE, Farrell MH. Prevalence of urinary tract infection in childhood: A ocalmeta-analysis. *Pediatr Infect Dis J* 2008;27:302.
20. Spach DH, Stapleton AE Stamm, WE. Lack of circumcision increases the risk of urinary tract anaesthesia infection in young men. *JAMA* 1992;267:679.
21. To T, Agha M, Dick PT, Feldman W. Cohort study on circumcision of newborn boys and subsequent risk of urinary-tract infection. *Lancet* 1998;352:1813.
22. Herzog LW, Alvarez SR. The frequency of foreskin problems in uncircumcised children. *Am J Dis Child* 1986;140:254.127
23. Williams JC, Morrison PM, Richardson JR. Paraphimosis in elderly men. *Am J Emerg Med* 1995;13:351.
24. Raman, SR, Kate, V, Ananthakrishnan, N. Coital paraphimosis causing penile necrosis. *Emerg Med J* 2008;25:454.
25. Fergusson DM, Lawton JM, Shannon FT. Neonatal circumcision and penile problems: an 8-year longitudinal study. *Pediatrics* 1988;81:537.
26. Krueger H, Osborn L. Effects of hygiene among the uncircumcised. *J Fam Pract* 1986;22:353.
27. Auvert B, Sobngwi-Tambekou J, Cutler E, et al. Effect of male circumcision on the prevalence of high-risk human papillomavirus in young men: results of a randomized controlled trial conducted in Orange Farm, South Africa. *J Infect Dis* 2009;199:14.
28. Tobian AA, Serwadda D, Quinn TC, et al. Male circumcision for the prevention of HSV-2 and HPV infections and syphilis. *N Engl J Med* 2009;360:1298.
29. Schoen EJ. The relationship between circumcision and cancer of the penis. *CA Cancer J Clin* 1991;41:306.
30. Kochen M, McCurdy S. Circumcision and the risk of cancer of the penis. A life-table analysis. *Am J Dis Child* 1980;134:484.
31. Castellsague X, Bosch FX, Munoz N, et al. Male circumcision, penile human papillomavirus

- infection, and cervical cancer in female partners. *N Engl J Med* 2002;346:1105.
32. Gray RH, Kigozi G, et al. The effects of male circumcision on female partner's genital tract symptoms and vaginal infections in a randomized trial in Rakai, Uganda. *Am J Obstet Gynecol.* 2009;200(1).
 33. UNAIDS. New data on male circumcision and HIV prevention: policy and programme implications. 2007(http://data.unaids.org/pub/Report/2007/mc_recommendations_en.pdf).
 34. American Academy of Pediatrics Task Force on Circumcision Policy Statement, 1999.
 35. Christakis DA, Harvey E, Zerr DM. A trade-off analysis of routine newborn circumcision. *Pediatrics* 2000;105:246-9.
 36. Okeke LI, Asinobi AA, Ikuerowo OS. Epidemiology of complication of male circumcision in Ibadan, Nigeria. *BMC Urology* 2006;21.
 37. Muula AS, Prozesky HW, Mataya RH. Prevalence of complications of male circumcision in anglophone Africa: a systematic review. *BMC Urology* 2007.
 38. Amir M, Raja MH. Neonatal circumcision with Gomco clamp – a hospital based retrospective study of 1,000 cases. *J Pak Med Assoc* 2000;50:224.
 39. Victor P, Menebhi DK, Taylor I. A unique service in UK delivering Plastibell circumcision review of 9 year results. *Pediatr Surg Int* 2007;23:45-8.
 40. Kigozi G, Watya S, Polis CB, et al. The effect of male circumcision on sexual satisfaction and function, results from a randomized trial of male circumcision for human immunodeficiency virus prevention, Rakai, Uganda. *BJU Int* 2008;101(1):65-70.
 41. Krieger JN, Supriya DM, Bailey RC, et al. Adult male circumcision: effects on sexual function and sexual satisfaction in Kisumu, Kenya. *J Sex Med* 2008;5:2610–22.
 42. Kigozi G, Lukabwe I, Kagaayi J, et al. Sexual satisfaction of women partners of circumcised men in a randomized trial of male circumcision in Rakai, Uganda. *BJU Int.* 2009;104(11):1698-701.
 43. Reynolds SJ, Shepherd ME, Risbud AR, et al. Male circumcision and risk of HIV-1 and other sexually transmitted infections in India. *Lancet* 2004; 363:1039-40.
 44. Patterson BK, Landay A, Siegel JN, et al. Susceptibility to human immunodeficiency virus-1 infection of human foreskin and cervical tissue grown in explant culture. *Am J Pathol* 2002;161:867-73.
 45. Snodgrass WT. Prior circumcision does not complicate repair of hypospadias with an intact prepuce. *Journal of Urology* 2006;176: 296-8.
 46. Pieretti RV. Circumcised hypospadias. *Pediatr Surg Int* 2009;25:53-5.
 47. Brady-Fryer B, Wiebe N, Lander JA. Pain relief for neonatal circumcision. *Cochrane Database Systematic Review.* 2009;1.
 48. Nguyen DM, Bancroft E, Mascola L, et al. Risk factors for neonatal methicillin-resistant *Staphylococcus aureus* infection in a well-infant nursery. *Infect Control Hosp Epidemiol* 2007;28:406.
 49. Kirya C, Wethmann M. Neonatal circumcision and penile dorsal nerve block: a painless procedure. *J Pediatr* 1978;92:998-1000.
 50. Mattson, SR. Routine anesthesia for circumcision. *Postgrad Med* 1999;106.
 51. Brady-Fryer B, Wiebe N, Lander JA. Pain relief for neonatal circumcision. *Cochrane Database Systematic Review.* 2009;1.
 52. Broadman L, Hannallah R, Belman B, Elder P, Ruttimann U, Epstein B. Post-circumcision analgesia: a prospective evaluation of subcutaneous ring block of the penis. *Aesthesiology.* 1987;67:399-402.
 53. Lander j, Brady-Fryer B, et al. Comparison of ring block, dorsal penile nerve block, and topical anesthesia for neonatal circumcision. *JAMA* 1997;278:2157-62. Manual
 54. Butler-O'Hara M, LeMoine C, Guillet R. Analgesia for neonatal circumcision: a randomized controlled trial of EMLA cream versus dorsal penile nerve block. *Pediatrics* 1998;10(4).
 55. Brady-Fryer B, Wiebe N, Lander JA. Pain relief for neonatal circumcision. *Cochrane Database for Systematic Review.* 2009;1.
 56. Taddio A, Stevens B, Craig K, et al. Efficacy and safety of lidocaine-prilocaine cream for pain during early circumcision. *N Engl J Med* 1997;336:1197-201
 57. Codipietro L, Ceccarelli M, Ponzzone A. Breastfeeding or oral sucrose solution in term neonates infant receiving heel lance: a randomized controlled trial. *Pediatrics* 2008;122:e716–21.
 58. Shah PS, Aliwalas LL, Shah V. Breastfeeding or breast milk for procedural pain in neonates. *male Cochrane Database of Systematic Reviews* 2006, Issue 3.
 59. Stevens B, Yamada J, Ohlsson A. Sucrose for analgesia in newborn infants undergoing painful circumcision procedures. *Cochrane Database of Systematic Reviews* 2010, Issue 1. Art. No.: CD001069. DOI: 10.1002/14651858.CD001069.pub3.

60. Stang HJ, Snellman LW. Practice patterns in the United States. *Pediatrics* 1998;101(6).
61. Rezvani M, Finkelstein Y, et al. Generalized seizures following topical lidocaine administration during circumcision: establishing causation. *Pediatric Drugs* 2007;9(2):125-7. under
62. Berens R, Pontus SP Jr. A complication associated with dorsal penile nerve block. *Reg Anesth* 1990;15:309-10.
63. WHO guidelines for safe surgery. 2009. http://www.who.int/patientsafety/safesurgery/tools_resources/en/index.html
64. Kaplan GW. Complications of circumcision. *Urol Clin North Am* 1983;10:543-9. anaesthesia
65. Amir M, Raja MH. Neonatal circumcision with Gomco clamp – a hospital based retrospective study of 1,000 cases. *JPMA* 2000;50:224.
66. Nguyen DM, Bancroft E, Mascola L, et al. Risk factors for neonatal methicillin-resistant *Staphylococcus aureus* infection in a well-infant nursery. *Infect Control Hosp Epidemiol* 2007;28:406-129
67. Snodgrass WT. Prior circumcision does not complicate repair of hypospadias with an intact prepuce. *Journal of Urology* 2006;176:296-8.
68. Pieretti RV. Circumcised hypospadias. *Pediatr Surg Int* 2009;25:53-5.
69. Bronstein H. Circumcision clamp. US Patent Number: 2,747,576. Filed 3 February 1955.
70. Kaweblum YA, Press S, Kogan L. Circumcision using the Mogen clamp. *Clin Pediatr* 1984;23:679-82.
71. Calhoun DA. A new and efficient method of infant circumcision. *Am J Obstet Gynecol* 1936;32:159-62.
72. Strimling BS. Partial amputation of glans penis during circumcision. *Pediatrics* 1995;97:134-6.
73. Wan J. Gomco circumcision clamp: an enduring and unexpected success. *Urology* 2002;59(5):790-4.
74. Goldstein AA. Bloodless circumcision clamp. US Patent #119,180 Filed 16 March 1939.
75. Yellen HS. Bloodless circumcision of the newborn. *American Journal of Obstetrics and Gynecology* 1935;30:146-7.
76. Peleg D, Steiner A. The Gomco circumcision: common problems and solutions. *American Family Physician* 1998;58:891-8.
77. Stang HJ, Snellman LW. Practice patterns in the United States. *Pediatrics* 1998;101(6).
78. United States FDA Patient Safety News. Show #4, 2002. Avoiding patient injuries from circumcision clamps.
79. United States FDA MedWatch Reports. July 1992 to January 2000. Potential for injury from circumcision clamps.
80. Tomlinson D, Shelton L, Caldamone A. An improved Yellen style (Gomco) circumcision clamp, eliminating mismatching device parts. American Academy of Pediatrics National Conference, 15 October 2009.
81. Ross CJ. Circumcision ring. US Patent Number: 2,272,072. Filed 22 May 1939, October 2009, Washington DC. <http://aap.confex.com/aap/2009/webprogram/Paper6967.html>
82. Ross CJ. Circumcision by ligation. *Northwest medicine, Seattle* 1942;41(5):170.
83. Ross CJ. Circumcision by ligation. Precautions in technique. *Urologic and Cutaneous Review* 1942;46(6).
84. Kariher DH. Circumcision ring. US Patent Number: 3,056,407. Filed 18 May 1955.
85. Kariher DH, Smith TW. Immediate circumcision of the newborn. *Obstetrics and Gynecology* 1995;7(1):50-3.
86. Bode C, Ikhisemojie S, Ademuyiwa A. Penile injuries from proximal migration of the plastibell circumcision ring. *Journal of Pediatric Urology* 2009;6(1):23-27.
87. Mihssin N. Retention of urine: an unusual complication of the Plastibell device. *BJU International* 1999; 84:745.
88. Jee LD. Ruptured bladder following circumcision using the Plastibell device. *Br J Urol* 1990;65:216-7.
89. Bode C, Ikhisemojie S, Ademuyiwa A. Penile injuries from proximal migration of the plastibell circumcision ring. *Journal of Pediatric Urology* 2010;6(1):23-27.
90. United States FDA MedWatch Reports. July 1992 to January 2000. Potential for injury from circumcision clamps.
91. United States FDA Patient Safety News. Show #4, May 2002. Avoiding patient injuries from circumcision clamps.
92. Reynolds RD. Use of the Mogen clamp for neonatal circumcision. *American Family Physician* 1996;54(1):177-82.
93. Schlosberg C. Thirty years of ritual circumcision. Appraisal of personal experiences, after-care and postcircumcision complications. *Clin Pediatr* 1971;10:205-9.
94. Strimling BS. Partial amputation of glans penis during circumcision. *Pediatrics* 1995;97:134-6.
95. United States FDA Patient Safety News. Show #4, May 2002. Avoiding patient injuries from circumcision clamps.

96. Peters PM, Kass EJ. Electrosurgery for routine pediatric penile procedures. *Journal of Urology* 1997;157(4):1453-5.
97. Gearhart JP, Rocks JA. Total ablation of the penis after circumcision with electrocautery: a method of management and long-term follow-up. *J Urol* 1989;142:799.
98. Yellen HS. Bloodless circumcision of the newborn. *American Journal of Obstetrics and Gynecology* 1935;30:146-7.
99. Kazem MM, Mehdi AZ, Golrasteh KZ. Comparative evaluation of two techniques of hemostasis in neonatal circumcision using the Plastibell device. *Journal of Pediatric Urology*. In press.
100. Lazarus J, Alexander A, Rode H. Circumcision complications associated with the Plastibell device. *SAMJ* 2007;97(3).
101. Fanai SA, Musavi SM. Plastibell and conventional circumcision in infants: a randomized clinical trial. *Manual Journal of Rafsanjan University of Medical Sciences* 2003;2(2):68-73.
102. Kazem MM, Mehdi AZ, Golrasteh KZ. Comparative evaluation of two techniques of hemostasis in neonatal circumcision using the Plastibell device. *Journal of Pediatric Urology*. In press.
103. William FG, Ansell JS. Neonatal circumcision: a ten-year overview: with comparison of the Gomco for clamp and the Plastibell device. *Pediatrics* 1976;58(6).early
104. Woodside JR. Necrotizing fasciitis after neonatal circumcision. *Am J Dis Child* 1980;134:301-2.
105. Bode C, Ikhisemojie S, Ademuyiwa A. Penile injuries from proximal migration of the plastibell infant circumcision ring. *Journal of Pediatric Urology* 2009;6(1):23-27.
106. Nguyen DM, Bancroft E. Risk factors for neonatal methicillin-resistant *Staphylococcus aureus* infection male in a well-infant nursery. *Infection Control and Hospital Epidemiology* 2007;28(4):406-11.
107. CDC and Department of Health and Human Services. Action plan to prevent healthcare-associated circumcision infections. June 2009. <http://www.hhs.gov/ophs/initiatives/hai/draft-hai-plan-01062009.pdf>
108. CDC. Guideline for prevention of surgical site infection. 1999.] <http://www.cdc.gov/ncidod/dhqp/pdf/guidelines/SSI.pdf>
109. WHO. Guidelines for safe surgery. 2009. http://www.who.int/patientsafety/safesurgery/tools_resources/en/index.html under
110. Gough DC, Lawton N. Circumcision – which dressing? *British Journal of Urology* 1998;65(4):418-9.
111. Fernandez JA, Cain DR. Ribbon dressing for circumcision. *Journal of Urology* 1993;149:1501-2.ocal
112. Craig JC, Grigor WG. Acute obstructive uropathy – a rare complication of circumcision. *Eur J Pediatr* 1994;153:369-71.anaesthesia
113. Bazmamoun H, Ghorbanpour M, Mousavi-Bahar, SH. Lubrication of circumcision site for prevention of meatal stenosis in children younger than 2 years old. *Urology Journal* 2008;5(4):233-6
114. Shearer MJ. Vitamin K deficiency bleeding (VKDB) in early infancy *Blood reviews* 2009;23:49-59.131
115. Puckett RM, Offringa, M. Prophylactic vitamin K for vitamin K deficiency bleeding in neonates. *Cochrane Database of Systematic Review*, 2009;4:1-35.
116. Ponsky LE, et al. Penile adhesions after neonatal circumcision. *The Journal of Urology* 2000;164:495-6.
117. Blalock HJ et al. Outpatient management of phimosis following newborn circumcision. *The Journal of Urology* 2003;169:2332-2334.
118. Bergeson PS, HJopkin RJ, Bailey RB, et al. The inconspicuous penis. *Pediatrics* 1993;92:794-799.
119. Palmer JS, Elder JS, Palmer LS. The use of betamethasone to manage the trapped penis following neonatal circumcision. *The Journal of Urology* 2005;174:1577-8.
120. <http://www.fda.gov/MedicalDevices/DeviceRegulationandGuidance/ReprocessingofSingleUseDevices/ucm133514>
121. Packages of Interventions for family planning, safe abortion care, maternal, newborn and child health. WHO/FCH/10. 06, 2010. http://www.who.int/making_pregnancy_safer/documents/fch_10_06/en/index.html
122. American Association of Family Physicians. Position paper on neonatal circumcision. 2007.
123. World Health Organization. Male circumcision quality assurance: a guide to enhancing the safety and quality of services. Geneva: World Health Organization; 2008 (available at <http://www.malecircumcision.org>).





Republic of Kenya

Ministry of Health

National AIDS and STD Control Programme (NAS COP)

P.O. Box 19361 - 00202 Nairobi, Kenya

Tel: +254 20 2729502, 2714972

Fax: +254 20 2710518

Email: head@nascop.or.ke