

# Voluntary Medical Male Circumcision Guidance Document

---

Proper Decontamination, Storage, Transport and Disposal of  
Disposable Non-Sharp Metal Instruments

January 2013

# Voluntary Medical Male Circumcision Guidance Document

---

Proper Decontamination, Storage, Transport and Disposal of Disposable Non-Sharp Metal Instruments

January 2012

---

Nicole Pahl, Technical Advisor, Health Care Waste Management  
Scott Ackerson, Specialist, Health Care Waste Management



Providing quality medicines for people  
living with and affected by HIV and AIDS



## **About SCMS**

The Supply Chain Management System (SCMS) was established to enable the unprecedented scale-up of HIV/AIDS prevention, care and treatment programs in the developing world. SCMS procures and distributes essential medicines and health supplies, works to strengthen existing supply chains in the field, and facilitates collaboration and the exchange of information among key donors and other service providers. SCMS is an international team of 13 organizations funded by the US President's Emergency Plan for AIDS Relief (PEPFAR). The project is managed by the US Agency for International Development.

This document was made possible through support provided by the President's Emergency Plan for AIDS Relief (PEPFAR) through the US Agency for International Development, under the terms of contract number GPO-I-00-05-00032-00. The opinions expressed herein are those of the author(s) and do not necessarily reflect the views of the US Agency for International Development or the US government.

## **Recommended Citation**

Ackerson S. and Pahl. N. 2013. *Voluntary Medical Male Circumcision Guidance Document*. Submitted to the US Agency for International Development by the Supply Chain Management System (SCMS).

This document may be reproduced if credit is given to SCMS.

---

## **Supply Chain Management System**

1616 Fort Myer Drive, 12<sup>th</sup> Floor  
Arlington, VA 22209 USA  
Telephone: +1-571-227-8600  
Fax: +1-571-227-8601  
E-mail: [scmsinfo@pfscm.org](mailto:scmsinfo@pfscm.org)  
Website: [www.scms.pfscm.org](http://www.scms.pfscm.org)



# Table of Contents

---

## Contents

CONTAINERIZATION REQUIREMENTS .....	8
REUSABLE SPECIAL WASTE RECEPTACLES.....	9
STOCK CONTROL.....	9
EQUIPMENT REQUIREMENT.....	10
DILUTION OF SODIUM HYPOCHLORITE SOLUTION.....	11
DISPOSAL OF SODIUM HYPOCHLORITE SOLUTION .....	12
DECONTAMINATION PROCEDURE .....	12
COLLECTION:.....	15
RECORDING: .....	15
SHARPS PIT/CONCRETE VAULT .....	18
RECYCLING/SMELTING .....	19
ENCAPSULATION.....	20



# Acronyms

---

HCF	Health Care Facility
HCRW	Health Care Risk Waste
HCW	Health Care Waste
HCWM	Health Care Waste Management
IPC	Infection Prevention Control
MC	Male Circumcision
PPE	Personnel Protective Equipment
QA	Quality Assurance
SCMS	Supply Chain Management System
SOP	Standard Operating Procedure
TOT	Training of Trainers
VMMC	Voluntary Medical Male Circumcision
WHO	World Health Organization

# Definitions

---

Term	Definition
Anatomical Waste/Pathological Waste	Anatomical Waste (also often referred to as pathological waste) consists of tissues, organs, body parts, blood and bodily fluids from patients, human fetuses and animal carcasses, but excludes teeth and hair.
Biohazard Symbol	 This symbol is required on the side of all infectious and sharp waste containers
Caution Symbol	 This symbol is required on the side of all decontaminated instrument storage containers.
Cleaning	Removal of contamination from an item to the extent necessary for the further processing or for the intended use.
Color-coding System	A system for relating the contents of packaging / containers by using different colors.
Contaminated	State of having been actually or potentially in contact with infectious agents.
Decontamination	The process by which medical devices, instruments, and equipment are rendered safe for personnel to handle.
Decontamination Area	Area of a health care facility designated for collection, retention, and cleaning of soiled and/or contaminated items.
Health Care General Waste	Comparable to domestic/municipal/household waste, this type of waste does not pose special handling problems or hazards to human health or to the environment.
Health Care Risk Waste	All waste generated by health-care establishments, research facilities, and laboratories that could pose a health risk to health worker, the public, or the environment.
Hypochlorite Solutions	Widely used for decontaminating surgical instruments, laboratory equipment and spot-disinfection of countertops and floors.in healthcare facilities
Infectious Waste	<p>This is waste that may have been in contact with human blood or bodily fluid and may have the ability to spread disease.</p> <p>Examples: gauze, cotton, dressings, laboratory cultures, IV fluid lines, blood bags, gloves, anatomical waste, surgical instruments and pharmaceutical waste.</p>
Microorganism	Entity of microscopic size, encompassing bacteria, fungi, protozoa, and viruses.

<b>Minimum recommended concentration (MRC)</b>	Minimum concentration at which a liquid chemical sterilant is suitable for the decontamination procedure.
<b>Non-Infectious Waste</b>	This is general waste that presents no risk to persons who handle it.  Examples: paper, packaging materials, office supplies, drink containers, hand towels, boxes, glass, plastic bottles, and food.
<b>Pharmaceutical Waste</b>	Pharmaceutical waste includes expired, unused, spilt and contaminated pharmaceutical products; and drugs, vaccines and sera that are no longer usable as medication and need to be disposed of appropriately.
<b>Personnel Protective Equipment (PPE)</b>	Specialized clothing or equipment worn by an employee for protection against a hazard.
<b>Sharp Waste</b>	This is waste that may puncture the skin and cause disease.  Examples: needles, infusion sets, scalpels, knives, blades, lancets, and broken glass.
<b>Special Waste</b>	Special waste is comprised of infectious and hazardous waste, which has physical characteristics that differ from anatomical / pathological, sharp and general waste, but requires special precautions in the packaging, handling, treating and disposing of this waste.  Example: non-sharp surgical instruments





# Introduction

---

Voluntary Medical Male Circumcision (VMMC) is an activity conducted by qualified health care personnel in a health care facility (HCF). Henceforth, this activity generates health care waste, which is composed of both non-hazardous and hazardous elements. The improper management of health care waste generated during circumcision activities carries a risk of infection and / or injury for health care professionals and patients, if not managed correctly. To avoid negative impacts on public health and the environment, it is essential to develop safe and reliable methods for the handling and treatment of health care risk waste (HCRW) including Disposable Non-Sharp Metal Instruments. SCMS is currently developing a comprehensive toolkit that will provide VMMC Implementing Partners with tools to develop a sustainable and environmentally sound health care waste management system. This product will be available in early 2013.

HCRW passes through a number of different stages, from generation to treatment and, finally, disposal (also known as the health care waste management cycle or cradle-to-grave cycle). Service providers must have clear Standard Operating Procedures on the segregation, handling, storage, transport, treatment and disposal of Non-sharp Metal Instruments as well as other types of HCRW to cater for each step of the cycle. It is important to remember that responsibility lies, always, with the generator of the waste or their agents.

The easiest way to establish a proper health care waste management system is to draft a waste management plan based on enclosed norms, standards, and/or guidelines as presented in this document (certain elements will emerge as country-specific). When designing a waste management plan it is essential to assess local infrastructure to determine which relevant options will best suit the proper handling, treatment and disposal of Disposable Non-Sharp Instruments.

This document has been created to address the cradle-to-grave journey of disposable non-sharp metal instruments from Disposable Male Circumcision Kits used in VMMC activities. This brief guideline will address recommended containerization, handling, storage, collection, and transport and disposal best practices. It is imperative that minimum standards are attained and maintained in the best interests of protecting all the people in the chain, the environment and the reputation of the project as a whole. Standard Operation Procedures (SOPs) are available to address each aspect in greater detail. Visual Aids are also available for display in relevant work areas to facilitate on-the-job best practice.

SCMS and the US Government are not advocating the use of any of any particular treatment/disposal method, only presenting options that may be present in-country and recommended by the WHO. SCMS is recommending Implementing Partners to establish proper protocols for the handling, treating and disposing of Disposable Non-Sharp Metal Instruments by drafting a waste management plan based upon local norms and standards, and/or guidelines presented in this document.

# Identification, Segregation, Color-Coding and Containerization





The effective management of HCW is considered the basic elements of waste minimization, identification and proper segregation of the waste. Segregation is the responsibility of the generator of the waste at the point of generation.

Segregation is the process of separating different types of waste at the point of generation and keeping them isolated from each other for good reason. Appropriate resource recovery and recycling technique can be applied to each separate waste stream where applicable.

To improve segregation efficiency and minimization, the correct use of containers, proper placement and labeling of containers must be carefully determined.

All the components of the used Disposable Male Circumcision Kit are to be segregated into the following identified waste streams:

Table 1: Waste Streams: Disposable Male Circumcision Kit

WASTE STREAMS Disposable Male Circumcision Kit				
GENERAL	INFECTIOUS	SHARPS	SPECIAL ( Disposable Non-Sharp Metal Instruments) <sup>(b)</sup>	PHARMACEUTICAL
				
Packaging <sup>(a)</sup> (uncontaminated)	Surgical gloves	Scalpel	Forceps	Lignocaine
	Paranet Gauze	Syringe + needle (no denotching)	Needle-holder & Scissors combo	
	Apron	Sutures	Mosquito Forceps Curved	
	Gauze 12 ply		Forceps Straight	
	Multipurpose Tray		Mosquito forceps straight	
	Alcohol swabs			
	Examination gloves			
	Surgical tape plaster			
	O-Drape Towel			
	Removed foreskin (anatomical / pathological waste)			

(a) Outer packaging/wrapping is general waste (i.e. cardboard, cellophane wrap, plastic wrap, cling film, cling wrap or food wrap).

(b) Instruments must be decontaminated then sterilized (Reusable) or disposed of (Non-reusable).

Figure 1: Waste Streams for Containerization



## Containerization Requirements

One of the core elements of sound health care waste management is **SAFE CONTAINERIZATION**. Once the waste generated has been packaged for disposal no one should be exposed to the contents as it is moved front point to point on its way to the disposal site.

It is therefore imperative that packaging / containers meet certain minimum standards.

**For example:** Sharps also are infectious but they are separated as a category because they can pierce or penetrate a bag putting handlers at risk of a needle-stick injury. This is why sharps are placed into a rigid plastic container. By same token, if a red bag is too thin to carry the weight of its contents, it can tear or break and spill them putting handlers at risk of infection. This is why health care waste management policies dictate a minimum quality standard for red bags.

1. Plastic bags with a capacity of 60 (sixty) liters or more must be at least 80 (eighty) microns in thickness.
2. Plastic bags with a capacity of less than 60 (sixty) liters must be at least 60 (sixty) microns in thickness.
3. Plastic bags used as barriers in puncture resistant containers that are at no time removed from such puncture resistant containers, other than for the final treatment of the contents, must be at least 40 (forty) microns in thickness.
4. Plastic bags which are used as smaller intermediate barriers within a single ward or similar, and that are subsequently placed in puncture resistant and leak resistant containers or further plastic bags, must be at least 40 (forty) microns in thickness.
5. All plastic bags and disposable containers must be manufactured from polypropylene or polyethylene polymers to minimize environmental impacts when disposed by incineration, or treated by means of any other suitable alternative technology.
6. Rigid puncture resistant containers shall be leak resistant, have fitted covers, and be kept clean and in good repair.
7. Lids used for disposable sharps containers must be secured in such a way that they cannot be reopened once closed, without major structural damage to the container.
8. For the purpose of ensuring sufficient tensile strength, the maximum allowable percentage of recycled materials in all liners is 10 (ten) % provided that for outer packaging the maximum allowable percentage of recycled materials is 15 (fifteen) %.

### ***Reusable Special Waste Receptacles***

Only the contents of the plastic bin containing disposable metal instruments will go for pit or concrete vault burying, or recycling. The container itself can be reused and rotated on a one-out-one-in basis.

### ***Stock Control***

Things may go out of control when the correct tools / products are unavailable and personnel are forced to innovate. Ensure sound stock control by monitoring stock and ordering replacement stock in good time to meet demand.

# Decontamination of Disposable Non-Sharp Instruments

---

This section outlines the proper procedures for the decontamination of disposable non-sharp metal instruments in accordance with ANSI/AAMI ST79: 2010 *Comprehensive guide to steam sterilization and sterility assurance in health care facilities*. This section describes methods for presoaking, decontaminating, and packaging of instruments.

Responsibility for instrument decontamination should be assigned to qualified individuals who have demonstrated competence in all aspects of the process. Refer to Annex for visuals and protocols.

Decontamination is achieved by presoaking and manually cleaning disposable non-sharp metal instruments in a sodium hypochlorite solution. The sodium hypochlorite solution contains a chlorine compound that destroys infectious agents and renders the items safe for handling or disposal. After decontamination, the instruments must be thoroughly rinsed of all chemicals with potable water and dried before undergoing sterilization or transport.

## Equipment Requirement

It is essential to use the proper equipment when decontaminating disposable non-sharp metal instruments to protect the individual and environment from exposure and/or harm.

Table2: Equipment Requirement



Name	Quantity
<b>Equipment</b>	
10 liter Stainless Steel Bucket with Lid and Appropriate Biohazard signage	3
Instrument Brush with Nylon Bristles	1
Stainless Steel Mixing Spoon with handle	1
Sealable Plastic Storage Container with Appropriate Caution Signage	2
Sodium Hypochlorite (Commercial Grade household Sodium Hypochlorite)	3 liters
Liter Measuring Cup	1
Cloth Towels	2
<b>PPE (per person)</b>	
Elbow Length Utility Gloves	1 pair
Face Shield or Goggles	1 pair
Heavy Plastic Apron	1
Rubber Gun Boots	1 pair

## Dilution of Sodium Hypochlorite Solution

1. Put on required PPE for the decontamination of disposable non-sharp metal instruments, including reusable utility gloves, apron, rubber boots, and face protection (goggles or full-length face shields).
2. Determine the percentage of active sodium hypochlorite in the commercial grade sodium hypochlorite solution by reading the active ingredients on the back side of the bottle. (Note: Sodium Hypochlorite concentration will range from approximately 1% to 10%).
3. Using the tables found in the Annex of this document, determine the correct amount of sodium hypochlorite and room temperature water required to make the appropriate solution mixture.
4. Using the appropriate concentrations for the vessel size, carefully pour the sodium hypochlorite and then the water into the bucket. Use the stainless steel mixing spoon to gently mix the solution.

Figure 2: Mixing of Sodium Hypochlorite Solution

**Mixing of Sodium Hypochlorite Solution**









Sodium Hypochlorite Concentration (3-5%)				Sodium Hypochlorite Concentration (6-10%)				
Total Volume of Bucket/ Container In Litres (L)	Amount of Water In Litres (L)	Amount of Water In Millilitres (ML)	Amount of Sodium Hypochlorite In Litres (L)	Total Volume of Bucket/ Container In Litres (L)	Amount of Water In Litres (L)	Amount of Water In Millilitres (ML)	Amount of Sodium Hypochlorite In Litres (L)	
1	.91	910	0.09	90	1	.96	960	0.04
2	1.82	1820	0.18	180	2	1.92	1920	0.08
3	2.73	2730	0.27	270	3	2.88	2880	0.12
4	3.64	3640	0.36	360	4	3.84	3840	0.16
5	4.55	4550	0.45	450	5	4.8	4800	0.2
6	5.46	5460	0.54	540	6	5.76	5760	0.24
7	6.37	6370	0.63	630	7	6.72	6720	0.28
8	7.28	7280	0.72	720	8	7.68	7680	0.32
9	8.19	8190	0.81	810	9	8.64	8640	0.36
10	9.1	9100	0.9	900	10	9.6	9600	0.4

**1** Put on required Personal Protective Equipment, including: reusable utility gloves, apron, rubber boots, hair net, and face protection (goggles or full-length face shields).

**2** Determine the percentage of active sodium hypochlorite by reading the active ingredients on the label of the bottle. (Note: sodium hypochlorite concentration will vary from approximately 1% to 10%).

**3** Using the tables above, determine the correct amounts of sodium hypochlorite and water required to make the decontamination solution mixture.

**4** Measure the appropriate volume of sodium hypochlorite solution found in table number 3.

**5** Carefully pour measured amount of sodium hypochlorite solution into a bucket.

**6** Measure the corresponding amount of water as indicated in table number 3.

**7** Carefully pour the water into the same bucket as the sodium hypochlorite solution. Use caution to avoid spillage.

**8** Use a stainless steel mixing spoon to gently mix the solution. Solution is now ready for use.

**9** After use, dilute the solution by adding water to the bucket, then properly dispose. Note: The Sodium hypochlorite solution should not be reused and a new solution must be made for each cleaning. If visibly contaminated, the solution should be replaced.

**Rationale:** The solution should ONLY fill the stainless steel bucket 1/2 full to leave room for instruments. Example: A 10 L bucket should ONLY hold 5 L of the diluted sodium hypochlorite solution. (Table: 4.4 L of water and 600 mL of Sodium Hypochlorite equals 5 L of diluted solution).



## **Disposal of Sodium Hypochlorite solution**

To properly dispose of the water bath and sodium hypochlorite solution, dilute the solution by adding water to top off the bucket and then pour the contents of the bucket out at a waste disposal site or down a drain. This practice reduces pollution risk to the environment.

*Note: The Sodium Hypochlorite solution should not be reused and a new solution must be made for every soaking. The solution should also be replaced if it becomes visibly contaminated.*

**WARNING:** Avoid skin and eye contact. Solution may sensitize and may cause skin irritation. This solution is extremely corrosive and harmful if swallowed.

*If the solution comes into contact with skin, flush thoroughly with water for 3 minutes. If the solution comes into contact with the eyes, flush with water immediately for 3 minutes and then seek medical attention.*

## **Decontamination Procedure**

### **3.4.1. Presoaking**

1. Presoaking non-sharp metal instruments in a sodium hypochlorite solution is recommended as this process moistens and loosens contaminants, thus making the cleaning step more effective.
2. Put on the appropriate PPE and prepare the sodium hypochlorite solution by following process above. Then, place buckets at each of the operating tables for easy access by clinical staff.
3. Place the non-sharp metal instrument in the bucket of active solution for a period of 20 minutes.

*Note: The bucket should not be filled more than  $\frac{3}{4}$  full of solution and instruments.*

*Note: The Sodium Hypochlorite solution should not be reused and a new solution must be made every soaking. The solution should also be replaced if it becomes visibly contaminated.*

### **3.4.2. Cleaning Process**

1. After a 20 minute presoaking process the non-sharp metal instruments should be cleaned to completely free the instrument of gross soil and infectious agents. The cleaning process will render the instruments safe for handling and disposal but not for reuse.
2. Put on the appropriate PPE and then follow process for mixing 'Dilution of Sodium Hypochlorite Solution' to prepare a second sodium hypochlorite solution. Fill a third stainless steel bucket  $\frac{3}{4}$  full of cold/room temperature water to create a water bath.
3. Remove half of the instruments from the presoak solution and place them into the new sodium hypochlorite solution bucket. One by one, scrub the instruments thoroughly with nylon bristle brush until all signs of contaminants have been removed.
4. Place the scrubbed instrument into the water bath for rinsing. Repeat this process until all non-sharp metal instruments have been scrubbed and are placed in the water bath.
5. Remove the instruments from the water bath, dry them with a cloth towel and place them onto a second towel for inspection.



- Request the site manager to inspect the instruments and sign that the instruments have been properly decontaminated.
- Place the instruments in sealable plastic storage containers with appropriate caution signage for temporary storage.

Figure 3: Visual Aid Decontamination Process

**Decontamination Process for Disposable Voluntary Medical Male Circumcision Kits**

Sodium Hypochlorite Concentration (3-5%)					Sodium Hypochlorite Concentration (6-10%)				
Total Volume of Bucket/ Container In Litres (L)	Amount of Water In Litres (L)	Amount of Water In Millilitres (mL)	Amount of Sodium Hypochlorite In Litres (L)	Amount of Sodium Hypochlorite In Millilitres (mL)	Total Volume of Bucket/ Container In Litres (L)	Amount of Water In Litres (L)	Amount of Water In Millilitres (mL)	Amount of Sodium Hypochlorite In Litres (L)	Amount of Sodium Hypochlorite In Millilitres (mL)
1	.91	910	0.09	90	1	.98	960	0.04	40
2	1.82	1820	0.18	180	2	1.92	1920	0.08	80
3	2.73	2730	0.27	270	3	2.88	2880	0.12	120
4	3.64	3640	0.36	360	4	3.84	3840	0.16	160
5	4.55	4550	0.45	450	5	4.8	4800	0.2	200
6	5.46	5460	0.54	540	6	5.76	5760	0.24	240
7	6.37	6370	0.63	630	7	6.72	6720	0.28	280
8	7.28	7280	0.72	720	8	7.68	7680	0.32	320
9	8.19	8190	0.81	810	9	8.64	8640	0.36	360
10	9.1	9100	0.9	900	10	9.6	9600	0.4	400

- Put on required Personal Protective Equipment, including: reusable utility gloves, apron, rubber boots, hair net, and face protection (goggles or full-length face shields).
- Determine the percentage of active sodium hypochlorite by reading the active ingredients on the label of the bottles. (Note: sodium hypochlorite concentration will vary from approximately 1% to 10%).
- Using the tables above, determine the correct amounts of sodium hypochlorite and water required to make the decontamination solution mixture.
- Measure the appropriate volume of sodium hypochlorite solution found in table number 3.
- Carefully pour measured amount of sodium hypochlorite solution into a bucket.
- Measure the corresponding amount of water as indicated in table number 3.
- Carefully pour the water into the same bucket as the sodium hypochlorite solution. Use caution to avoid spillage.
- Use a stainless steel mixing spoon to gently mix the solution. Repeat this process to create a second decontamination solution in a separate bucket.
- Place non-sharp metal instruments in one of the prepared decontamination solutions for 20 minutes to pre-soak the instruments.
- Fill a third stainless steel bucket ¾ full of cold/room temperature water to create a water bath.
- To scrub the instruments, place the three buckets next to each other: 1 bucket with pre-soaked instruments, 1 bucket of fresh decontamination solution, and 1 bucket of clean water for the water bath.
- Remove half of the instruments from the pre-soak solution and place them into the second bucket of fresh decontamination solution. One by one, scrub the instruments thoroughly with a nylon bottle brush until all signs of contaminants have been removed.
- Place the scrubbed instrument into the water bath for rinsing. Repeat this process until all non-sharp metal instruments have been scrubbed and are placed in the water bath.
- Remove instruments from water bath and place them on a clean, dry towel. After the instruments are dry, request the site manager to inspect them for rust or residual contamination. Fill bucket to top with water and then dispose of the contents.
- Place properly decontaminated single use instruments in sealable storage containers with appropriate caution signage for temporary storage.

# Temporary On-Site Storage

---

Decontaminated disposable non-sharp metal instruments should be stored in a heavy-duty rigid plastic container with the appropriate caution symbol on the container, and be placed in a secure storage area away from other health care risk waste to reduce the potential of cross-contamination. Traffic to this storage area should be limited to individuals who know how to handle the instruments properly.

The following Caution symbol must be displayed on the container.



Example 1: Temporary Storage – post-decontamination



## **Collection and Recording**

---

### **Collection:**

All decontaminated non-sharp instruments from VMMC facilities must be returned to a central or regional location for temporary, access-controlled storage until the product can be properly transported to an appropriate recycling/smelting facility or to a facility where it will be buried in a sharps pit / concrete vault.

All decontaminated non-sharp instruments must be appropriately and securely containerized with the correct labeling.

The receptacles/containers should not be filled past  $\frac{3}{4}$  full, or the designated fill-line on the container where applicable.

The transport contractor's driver will collect the instruments according to a schedule arranged by the VMMC Site's Manager. The instruments will be collected with the consignment / chain of custody form, and it is the responsibility of the VMMC Site's Manager to check the consignment / chain of custody form against the removed instruments, to record the details on the form, and to sign it accordingly. The transporter assumes responsibility for the instruments once it leaves the premises.

The driver will deliver the instruments to the regional or central location where the warehouse employees will sign the consignment form and take responsibility for the instruments until they are transported to the final facility of choice, depending on which disposal option has been enlisted.

### **Recording:**

All waste removed from the site must be accompanied by a consignment / chain of custody sheet or form (which is serialized for tracking and cross-referencing purposes), which includes the following information:

- Facility name and location (SOURCE of the waste)
- Date Collected (REMOVED from site)
- Contents of Container (DESCRIPTION of waste)
- Description of Container (TYPE and CAPACITY / VOLUME)
- WEIGHT of Container (usually in kgs –a platform scale is recommended for this purpose)
- SIGNATURES from site manager overseeing collection and transport company representative.

Example 1: of Consignment / Chain of Custody Form:

Chain of Custody Record for Medical Waste					Serial #:	
Final Destination (Name & Address)		Transport Company (Name & Address)				
Serial # on Transporter / Container	Product Description (Indicate Medical Waste, Sharps Waste, Instruments, etc.?)	Serial # on Bag in Transporter / Container (weight in kg)	Source / Location	Source / Location Representative's Signature	Witness of Destruction Signature	Date of Destruction
<i>E.g. A001</i>	<i>E.g. Medical Waste</i>	<i>e.g. A002 (9kg)</i>	<i>E.g. Matalcula JCI</i>	<i>e.g. MC Site Manager signs here</i>	<i>E.g. Incinerator Operator signs here once waste is incinerated</i>	<i>E.g. Date of Destruction recorded here</i>
Signature of Point of Delivery		Print Name and Date				
Signature of Transport Company Representative		Print Name and Date				

## **Off-Site Transport**

---

Once the disposable metal instruments have been decontaminated, they are rendered non-hazardous, and can therefore be transported in a vehicle that carries usable products, provided they are safely containerized and labeled correctly for identification purposes. They should be handled, packed and stacked with care such that they cannot topple and/or break during transit, with all packaging / containers remaining wholly intact en route to its destination.

The following symbol must be displayed on the container during transport.



Of course, the transport vehicle and driver's competency must be suitably certified to transport goods as per the laws of the country.

# Recommended Disposal Options

---

The final disposal of HCW is of the utmost importance. Failure to develop a suitable solution for the disposal of HCW can lead to public health and environmental issues that could negate the project's Environmental Monitoring and Mitigation Plan (EMMP).

Treatment / Disposal of hazardous waste depends on the local conditions and regulations. This section describes three internationally recognized methods of disposal for disposable non-sharp metal instruments. The project encourages the most environmentally favorable option wherever reasonably practicable.

*Note: All instruments no matter the option selected MUST be decontaminated and stored appropriately before disposal.*

## **Sharps Pit/Concrete Vault**

This method is especially suitable for the disposal of untreated used sharps and decontaminated non-sharp metal instruments. The following procedure is recommended for the safe burial of sharps and instruments through sharps pit/concrete vault

### **Construction Procedures**

- Dig a pit (minimum size of 1m x 1m x 1.8m), enough to accommodate sharps and instruments for an estimated period of time without reaching the ground water level. The site must be isolated and at least 30m away from the ground water supply sources and dwelling units.
- Construct concrete walls and slabs of the pit. Provide slab with an opening or manhole for easy deposition of collected sharps and syringes. The manhole should be extended a few centimeters above the soil surface to overcome infiltration of surface water.
- Deposit the collected safety boxes filled with used sharps and instruments inside the pit, concrete vault.
- Install a security fence around the site.
- When full fill the vault/pit with concrete to seal.

Figure 4: Construction Specifications

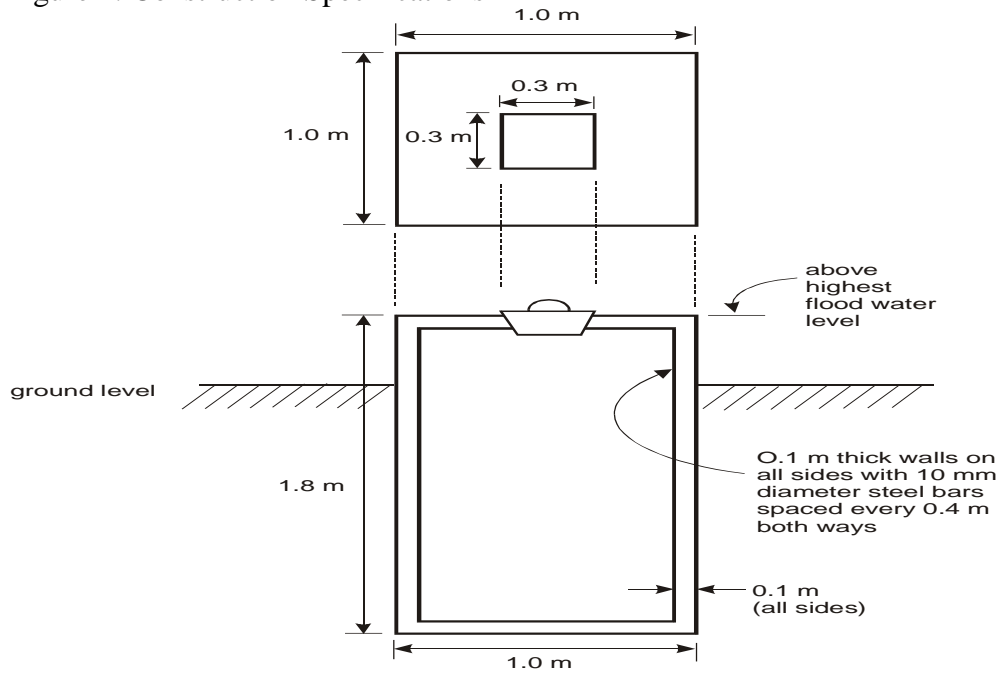

Reference: Management of Waste from Health care Activities - WHO - 2012 pending publication

## Handling Procedures

1. Wear the required PPE including reusable utility gloves, apron, protective shoes and face protection.
2. Remove the decontaminated non-sharp metal instruments from the secure storage area away from other health care risk waste to reduce the potential of cross-contamination and place into a rigid plastic container/wheelie bin.
3. Carefully transport the instruments in the rigid plastic container/wheelie bin to the pit/vault.
4. Slowly pour the instruments into the pit/vault.
5. Clean the rigid plastic container/wheelie bin using standard cleaning procedures.

## Recycling/Smelting

Recycling/Smelting is the process of turning used materials (waste) into new products to prevent waste of potentially useful materials, reduce the consumption of fresh raw materials, reduce energy usage, reduce air pollution (from incineration) and water pollution (from landfilling) by reducing the need for "conventional" waste disposal, and lower greenhouse gas emissions as compared to virgin production.

## Procedure

1. Transport will collect the instruments according to a schedule arranged by the central / regional warehouse manager, recycling/smelting facility and transport company / contractor, where applicable.
2. The instruments will be collected with a consignment / chain of custody form, and it is the responsibility of the central / regional warehouse manager to check the consignment / chain of custody form against the removed instruments, to record the details on the form, and to sign it accordingly. The transport company / contractor assumes responsibility for the instruments once it leaves the premises.
3. The driver will deliver the instruments to the recycling/smelting facility where the facility's representative will sign the consignment form and then assume final responsibility for the instruments.

## ***Encapsulation***

Encapsulation involves immobilizing the metal instruments in a solid block within a plastic or steel drum. Drums should be cleaned prior to use and should not have contained explosive or hazardous materials previously. They are filled to 75% capacity with non-sharp metal instruments, and the remaining space is filled by pouring in a medium such as cement or cement, plastic foam or bituminous sand. For ease and speed of filling, the drum lids should be cut open.

### **Procedure**

1. Care and precaution sure should be taken to avoid cuts to hands when placing instruments in the drums. It is important to wear the appropriate PPE such as thick rubber gloves, apron, steel-toed boots and goggles.
  2. Once the drums are filled to 75% capacity, the mixture of cement, sand and water (15:15:1 by weight) is added and the drum filled to capacity. A larger quantity of water may be required sometimes to attain a satisfactory liquid consistency.
  3. Steel drum lids should then be sealed by spot welding the seams.
  4. The sealed drums should be placed at the base of a landfill and covered with fresh municipal solid waste. For ease of movement, the drums may be placed on pallets which can then be put on a pallet transporter.
-



# References

---

1. ANSI/AAMI ST79: 2010 & A1:2010 & A2:2011 Comprehensive guide to steam sterilization and sterility assurance in health care facilities.
2. SANS 10248-1:2008 – South African National Standard 10248: Management of Healthcare Waste. Part 1: Management of Healthcare Waste from a Healthcare Facility.  
(<https://www.sabs.co.za/webstore/standards/product.php?id=14016220> )
3. Safe Management of Wastes from Health-care Activities. WHO / Annette Pruess, E. Giroult, P. Rushbrook. 1999. Download in pdf from <http://www.healthcarewaste.org/resources/documents/>
4. World Health Organization (WHO). 2005. Management of Solid Health- Care Waste at Primary Health- Care Centers : A Decision-Making Guide. Geneva : WHO.

# Annexure 1: Visual Aids

---

All print-ready copies of visual aids are available upon request. Email : Scott Ackerson [sackerson@pfscm.org](mailto:sackerson@pfscm.org) or visit the SCMS website : [www.scms.pfscm.org](http://www.scms.pfscm.org).

## Voluntary Medical Male Circumcision Health Care Waste Streams

STEP 1. IDENTIFY WASTE ACCORDING TO STREAM	Infectious	Sharps	General	Pharmaceutical	Special (4 steps)
<p><b>STEP 1.</b> IDENTIFY WASTE ACCORDING TO STREAM</p>	<ul style="list-style-type: none"> <li>• Gauze/dressings</li> <li>• Gloves</li> <li>• Anatomical waste (foreskin)</li> <li>• Blood</li> <li>• IV fluid lines</li> <li>• Plastic forceps</li> <li>• O-drape</li> <li>• Plastic container tray</li> <li>• Plastic apron</li> <li>• Alcohol swab</li> <li>• Test strip</li> </ul>	<ul style="list-style-type: none"> <li>• Syringes with needles (no detaching)</li> <li>• Infusion sets</li> <li>• Scalpels</li> <li>• Blades</li> <li>• Broken glass</li> <li>• Sutures</li> <li>• Lancet</li> </ul>	<ul style="list-style-type: none"> <li>• Packaging materials (uncontaminated)</li> <li>• Office supplies</li> <li>• Beverage containers</li> <li>• Hand towels</li> <li>• Boxes</li> <li>• Glass/plastic bottles</li> <li>• Food</li> <li>• Cardboard</li> <li>• Plastic/cellophane wrap</li> <li>• Cling wrap</li> <li>• Food wrap</li> </ul>	<ul style="list-style-type: none"> <li>• Damaged/unusable pharmaceuticals</li> <li>• Expired pharmaceuticals</li> </ul>	<ul style="list-style-type: none"> <li>• Needle holder</li> <li>• Suture scissors</li> <li>• Metal clamps</li> <li>• Metal forceps</li> </ul> <p><b>ADDITIONAL STEP- DECONTAMINATE</b></p>
<p><b>STEP 2.</b> SEGREGATE WASTE INTO APPROPRIATE CONTAINER</p>					
<p><b>STEP 3.</b> FINAL DISPOSAL/ DESTRUCTION*</p>	<ul style="list-style-type: none"> <li>• Dispose of via dedicated infectious waste pit</li> <li>• Incinerate</li> <li>• Treat via approved alternative technology</li> </ul>	<ul style="list-style-type: none"> <li>• Dispose of via dedicated sharps pit</li> <li>• Incinerate</li> <li>• Treat via approved alternative technology</li> </ul>	<ul style="list-style-type: none"> <li>• Separate components to be sent for recycling</li> <li>• Dispose of remaining waste in general landfill site</li> <li>• Incinerate</li> </ul>	<ul style="list-style-type: none"> <li>• Destroy in specialized incinerator</li> <li>• Incinerate and place in specialized waste landfill</li> <li>• Encapsulate</li> </ul>	<p>Disposal post decontamination:</p> <ul style="list-style-type: none"> <li>• Metals recycling</li> <li>• Bury in concrete vault</li> <li>• Encapsulate</li> </ul>



\*SCMS and the US Government are not endorsing the use of any of the particular treatment/disposal method, only presenting options that may be present in country and recommended by the WHO.



# Decontamination Process for Disposable Voluntary Medical Male Circumcision Kits



**1** Put on required Personal Protective Equipment, including: reusable utility gloves, apron, rubber boots, hair net, and face protection (goggles or full-length face shields).

**2** Determine the percentage of active sodium hypochlorite by reading the active ingredients on the label of the bottle. (Note: sodium hypochlorite concentration will vary from approximately .1% to 10%).

**3** Using the tables above, determine the correct amounts of sodium hypochlorite and water required to make the decontamination solution mixture.

Sodium Hypochlorite Concentration (3-5%)					Sodium Hypochlorite Concentration (6-10%)				
Total Volume of Bucket/ Container	Amount of Water	Amount of Sodium Hypochlorite	Amount of Sodium Hypochlorite	Total Volume of Bucket/ Container	Amount of Water	Amount of Sodium Hypochlorite	Amount of Sodium Hypochlorite		
In Liters (L)	In Liters (L)	In Milliliters (ML)	In Liters (L)	In Liters (L)	In Liters (L)	In Milliliters (ML)	In Milliliters (ML)		
1	.91	910	0.09	90	1	.96	960	0.04	40
2	1.82	1820	0.18	180	2	1.92	1920	0.08	80
3	2.73	2730	0.27	270	3	2.88	2880	0.12	120
4	3.64	3640	0.36	360	4	3.84	3840	0.16	160
5	4.55	4550	0.45	450	5	4.8	4800	0.2	200
6	5.46	5460	0.54	540	6	5.76	5760	0.24	240
7	6.37	6370	0.63	630	7	6.72	6720	0.28	280
8	7.28	7280	0.72	720	8	7.68	7680	0.32	320
9	8.19	8190	0.81	810	9	8.64	8640	0.36	360
10	9.1	9100	0.9	900	10	9.6	9600	0.4	400



**4** Measure the appropriate volume of sodium hypochlorite solution found in table number 3.

**5** Carefully pour measured amount of sodium hypochlorite solution into a bucket.

**6** Measure the corresponding amount of water as indicated in table number 3.

**7** Carefully pour the water into the same bucket as the sodium hypochlorite solution. Use caution to avoid spillage.

**8** Use a stainless steel mixing spoon to gently mix the solution. Repeat this process to create a second decontamination solution in a separate bucket.

**9** Place non-sharp metal instruments in one of the prepared decontamination solutions for 20 minutes to pre-soak the instruments.



**10** Fill a third stainless steel bucket  $\frac{3}{4}$  full of cold/room temperature water to create a water bath.

**11** To scrub the instruments, place the three buckets next to each other: 1 bucket with pre-soaked instruments, 1 bucket of fresh decontamination solution, and 1 bucket of clean water for the water bath.

**12** Remove half of the instruments from the pre-soak solution and place them into the second bucket of fresh decontamination solution. One by one, scrub the instruments thoroughly with a nylon bristle brush until all signs of contamination have been removed.

**13** Place the scrubbed instrument into the water bath for rinsing. Repeat this process until all non-sharp metal instruments have been scrubbed and are placed in the water bath.

**14** Remove instruments from water bath and place them on a clean, dry towel. After the instruments are dry, request the site manager to inspect them for rust or residual contamination. Fill bucket to top with water and then dispose of the contents.

**15** Place properly decontaminated single use instruments in sealable storage containers with appropriate caution signage for temporary storage.



# Personal Protective Equipment for Waste Handlers



# Mixing of Sodium Hypochlorite Solution



**1** Put on required Personal Protective Equipment, including: reusable utility gloves, apron, rubber boots, hair net, and face protection (goggles or full-length face shields).



**2** Determine the percentage of active sodium hypochlorite by reading the active ingredients on the label of the bottle. (Note: sodium hypochlorite concentration will vary from approximately 1% to 10%).

Sodium Hypochlorite Concentration (3-5%)				Sodium Hypochlorite Concentration (6-10%)			
Total Volume of Bucket/ Container	Amount of Water	Amount of Sodium Hypochlorite	Amount of Sodium Hypochlorite	Total Volume of Bucket/ Container	Amount of Water	Amount of Sodium Hypochlorite	Amount of Sodium Hypochlorite
In Litres (L)	In Litres (L)	In Millilitres (mL)	In Litres (L)	In Litres (L)	In Litres (L)	In Millilitres (mL)	In Litres (L)
1	.91	910	0.09	90	1	.96	960
2	1.82	1820	0.18	180	2	1.92	1920
3	2.73	2730	0.27	270	3	2.88	2880
4	3.64	3640	0.36	360	4	3.84	3840
5	4.55	4550	0.45	450	5	4.8	4800
6	5.46	5460	0.54	540	6	5.76	5760
7	6.37	6370	0.63	630	7	6.72	6720
8	7.28	7280	0.72	720	8	7.68	7680
9	8.19	8190	0.81	810	9	8.64	8640
10	9.1	9100	0.9	900	10	9.6	9600

**3** Using the tables above, determine the correct amounts of sodium hypochlorite and water required to make the decontamination solution mixture.



**4** Measure the appropriate volume of sodium hypochlorite solution found in table number 3.



**5** Carefully pour measured amount of sodium hypochlorite solution into a bucket.



**6** Measure the corresponding amount of water as indicated in table number 3.



**7** Carefully pour the water into the same bucket as the sodium hypochlorite solution. Use caution to avoid spillage.



**8** Use a stainless steel mixing spoon to gently mix the solution. Solution is now ready for use.



**9** After use, dilute the solution by adding water to the bucket, then properly dispose. Note: The Sodium Hypochlorite solution should not be reused and a new solution must be made for each cleaning. If visibly contaminated, the solution should be replaced.

## Annexure 2: Dilution Tables (Sodium Hypochlorite)

Sodium Hypochlorite Concentration (3-5%)				
Total Volume of Bucket/Container	Amount of Water	Amount of Water	Amount of Sodium Hypochlorite	Amount of Sodium Hypochlorite
Litres (L)	Litres (L)	Millilitres (ML)	Litres (L)	Millilitres (ML)
1	0.91	910	0.09	90
2	1.82	1820	0.18	180
3	2.73	2730	0.27	270
4	3.64	3640	0.36	360
5	4.55	4550	0.45	450
6	5.46	5460	0.54	540
7	6.37	6370	0.63	630
8	7.28	7280	0.72	720
9	8.19	8190	0.81	810
10	9.1	9100	0.9	900

Sodium Hypochlorite Concentration (6-10%)				
Total Volume of Bucket/Container	Amount of Water	Amount of Water	Amount of Sodium Hypochlorite	Amount of Sodium Hypochlorite
Litres (L)	Litres (L)	Millilitres (ML)	Litres (L)	Millilitres (ML)
1	0.96	960	0.04	40
2	1.92	1920	0.08	80
3	2.88	2880	0.12	120
4	3.84	3840	0.16	160
5	4.8	4800	0.2	200
6	5.76	5760	0.24	240
7	6.72	6720	0.28	280
8	7.68	7680	0.32	320
9	8.64	8640	0.36	360
10	9.6	9600	0.4	400

## **Annexure 3: Standard Operating Procedures**

---

All SOPs are available upon request. Email : Scott Ackerson [sackerson@pfscm.org](mailto:sackerson@pfscm.org) or visit the SCMS website : [www.scms.pfscm.org](http://www.scms.pfscm.org).

---